

Nikon

DIGITAL CAMERA

COOLPIX S1000pj

User's Manual

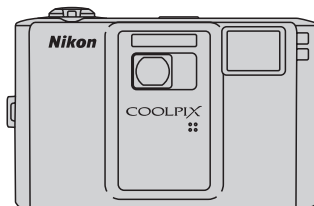

En

Trademark Information

- Microsoft, Windows and Windows Vista are either registered trademarks or trademarks of Microsoft Corporation in the United States and/or other countries.
- Macintosh, Mac OS, and QuickTime are trademarks of Apple Inc.
- Adobe and Acrobat are registered trademarks of Adobe Systems Inc.
- The SD logo is a trademark of the SD Card Association.
- PictBridge is a trademark.
- All other trade names mentioned in this manual or the other documentation provided with your Nikon product are trademarks or registered trademarks of their respective holders.

Introduction

First Steps



Basic Photography and Playback: Auto Mode



Shooting Suited to Scenes



Shooting Smiling Faces (Smart Portrait)



Focusing on a Moving Subjects



More on Playback/In-Camera Editing



Movies

Connecting to Televisions, Computers and Printers

MENU

Shooting, Playback and Setup Menus



Using the projector

Technical Notes

For Your Safety

To prevent damage to your Nikon product or injury to yourself or to others, read the following safety precautions in their entirety before using this equipment. Keep these safety instructions where all those who use the product will read them.



This icon marks warnings, information that should be read before using this Nikon product, to prevent possible injury.

WARNINGS

Turn off in the event of malfunction

Should you notice smoke or an unusual smell coming from the camera or AC adapter, unplug the AC adapter and remove the battery immediately, taking care to avoid burns. Continued operation could result in injury. After removing or disconnecting the power source, take the equipment to a Nikon-authorized service representative for inspection.

Do not disassemble

Touching the internal parts of the camera or AC adapter could result in injury. Repairs should be performed only by qualified technicians. Should the camera or AC adapter break open as the result of a fall or other accident, take the product to a Nikon-authorized service representative for inspection, after unplugging the product and/or removing the battery.

Do not use the camera or AC adapter in the presence of flammable gas

Do not use electronic equipment in the presence of flammable gas, as this could result in explosion or fire.

Handle the camera strap with care

Never place the strap around the neck of an infant or child.

Keep out of reach of children

Particular care should be taken to prevent infants from putting the battery or other small parts into their mouths.

Observe caution when handling the battery

The battery may leak or explode if improperly handled. Observe the following precautions when handling the battery for use in this product:

- Before replacing the battery, turn the product off. If you are using the AC adapter (available separately), be sure to unplug the AC adapter from an electrical power outlet.
- Only use a Rechargeable Li-ion Battery EN-EL12 (supplied). Charge the battery by inserting it in a Battery Charger MH-65 (supplied).
- When inserting the battery, do not attempt to insert it upside down or backwards.
- Do not short or disassemble the battery or attempt to remove or break the battery insulation or casing.
- Do not expose the battery to flame or to excessive heat.
- Do not immerse in or expose to water.
- Replace the terminal cover when transporting the battery. Do not transport or store with metal objects such as necklaces or hairpins.
- The battery is prone to leakage when fully discharged. To avoid damage to the product, be sure to remove the battery when no charge remains.
- Discontinue use immediately should you notice any change in the battery, such as discoloration or deformation.

Observe the following precautions when handling the battery charger

- If liquid from the damaged battery comes in contact with clothing or skin, rinse immediately with plenty of water.
- Keep dry. Failure to observe this precaution could result in fire or electric shock.
- Dust on or near the metal parts of the plug should be removed with a dry cloth. Continued use could result in fire.
- Do not handle the power cable or go near the battery charger during lightning storms. Failure to observe this precaution could result in electric shock.
- Do not damage, modify, forcibly tug or bend the power cable, place it under heavy objects, or expose it to heat or flames. Should the insulation be damaged and the wires become exposed, take it to a Nikon-authorized service representative for inspection. Failure to observe these precautions could result in fire or electric shock.
- Do not handle the plug or battery charger with wet hands. Failure to observe this precaution could result in electric shock.
- Do not use with travel converters or adapters designed to convert from one voltage to another or with DC-to-AC inverters. Failure to observe this precaution could damage the product or cause overheating or fire.

⚠ Use appropriate cables

When connecting cables to the input and output jacks, use only the cables provided or sold by Nikon for the purpose, to maintain compliance with product regulations.

⚠ Handle moving parts with care

Be careful that your fingers or other objects are not pinched by the lens cover or other moving parts.

⚠ CD-ROMs

The CD-ROMs supplied with this device should not be played back on audio CD equipment. Playing CD-ROMs on an audio CD player could cause hearing loss or damage the equipment.

⚠ Observe caution when using the flash

Using the flash close to your subject's eyes could cause temporary visual impairment. Particular care should be observed if photographing infants, when the flash should be no less than one meter (3 ft. 4 in.) from the subject.

⚠ Do not operate the flash with the flash window touching a person or object

Failure to observe this precaution could result in burns or fire.

⚠ Avoid contact with liquid crystal

Should the monitor break, care should be taken to avoid injury caused by broken glass and to prevent liquid crystal from the monitor touching the skin or entering the eyes or mouth.

⚠ Turn the power off when using inside an airplane or the hospital

Turn the power off while inside the airplane during take off or landing. Follow the instructions of the hospital when using while in a hospital. The electromagnetic waves given out by this camera may disrupt the electronic systems of the airplane or the instruments of the hospital.

⚠ Observe caution when using the projector

- Do not look directly into the projector window or project in or near human eyes. This could damage the eyes or result in visual impairment.
- Do not project towards the driver of a motor vehicle. Doing so may result in an automobile accident.

Notices

Notice for Customers in the U.S.A.

Federal Communications Commission (FCC) Radio Frequency Interference Statement

This equipment has been tested and found to comply with the limits for a Class B digital device, pursuant to Part 15 of the FCC rules. These limits are designed to provide reasonable protection against harmful interference in a residential installation. This equipment generates, uses, and can radiate radio frequency energy and, if not installed and used in accordance with the instructions, may cause harmful interference to radio communications. However, there is no guarantee that interference will not occur in a particular installation. If this equipment does cause harmful interference to radio or television reception, which can be determined by turning the equipment off and on, the user is encouraged to try to correct the interference by one or more of the following measures:

- Reorient or relocate the receiving antenna.
- Increase the separation between the equipment and receiver.
- Connect the equipment into an outlet on a circuit different from that to which the receiver is connected.
- Consult the dealer or an experienced radio/television technician for help.



Nikon
COOLPIX S1000pj

CAUTIONS

Modifications

The FCC requires the user to be notified that any changes or modifications made to this device that are not expressly approved by Nikon Corporation may void the user's authority to operate the equipment.

Interface Cables

Use the interface cables sold or provided by Nikon for your equipment. Using other interface cables may exceed the limits of Class B Part 15 of the FCC rules.

Notice for customers in the State of California

WARNING

Handling the cord on this product will expose you to lead, a chemical known to the State of California to cause birth defects or other reproductive harm.

Wash hands after handling.

Nikon Inc.,
1300 Walt Whitman Road
Melville, New York 11747-3064
USA
Tel: 631-547-4200

Notice for customers in Canada

CAUTION

This Class B digital apparatus complies with Canadian ICES-003.

ATTENTION

Cet appareil numérique de la classe B est conforme à la norme NMB-003 du Canada.

Notice for customers in Europe

This symbol indicates that this product is to be collected separately.



The following apply only to users in European countries:

- This product is designated for separate collection at an appropriate collection point. Do not dispose of as household waste.
- For more information, contact the retailer or the local authorities in charge of waste management.

This symbol on the battery indicates that the battery is to be collected separately.



The following apply only to users in European countries:

- All batteries, whether marked with this symbol or not, are designated for separate collection at an appropriate collection point. Do not dispose of as household waste.
- For more information, contact the retailer or the local authorities in charge of waste management.

Table of Contents

























For Your Safety	ii
WARNINGS.....	ii
Notices	v
Introduction	1
About This Manual	1
Information and Precautions.....	2
Parts of the Camera.....	4
The Camera Body	4
Remote Control ML-L4.....	6
Attaching the Camera Strap.....	7
The Monitor.....	8
Basic Operations.....	10
The  (Shooting Mode) Button.....	10
The  (Playback) Button.....	10
The Multi Selector.....	11
The MENU Button.....	12
Switching Between Tabs.....	12
Help Displays.....	13
The  (Projector) Button.....	13
First Steps.....	14
Charging the Battery	14
Inserting the Battery into the Camera.....	16
Removing the Battery.....	17
Turning On and Off the Camera.....	17
Setting Display Language, Date and Time	18
Inserting Memory Cards.....	20
Removing Memory Cards.....	20
 Basic Photography and Playback: Auto Mode	22
Step 1 Turn the Camera On and Select  (Auto) Mode	22
Indicators Displayed in  (Auto) Mode	23
Step 2 Frame a Picture	24
Using the Zoom.....	25
Step 3 Focus and Shoot	26
Shutter-release Button	27
Step 4 Playing Back and Deleting Pictures	28
Playing Back Pictures (Playback Mode).....	28
Deleting Pictures.....	28
Using the Flash.....	30
Setting the Flash Mode.....	30
Taking Pictures with the Self-timer	32
Macro Mode.....	33

Table of Contents

Exposure Compensation	34
Taking Pictures with the Remote Control	35
 Shooting Suited to Scenes	36
Shooting in Scene Mode	36
Selecting a Scene Mode	36
Features	37
Shooting in the Scene Mode Selected by the Camera (Scene Auto Selector)	43
Taking Pictures in Food Mode	45
Shooting for a Panorama	47
 Shooting Smiling Faces (Smart Portrait)	49
Shooting in Smart Portrait Mode	49
Smart Portrait Menu	51
 Focusing on a Moving Subjects	52
Subject Tracking Mode	52
 More on Playback/In-Camera Editing	54
Viewing Multiple Pictures: Thumbnail Playback	54
Calendar Display	56
Taking a Closer Look: Playback Zoom	57
Viewing Pictures by Date (List by Date Mode)	58
Selecting a Date in List by Date Mode	58
Using List by Date Mode	59
List by Date Menu	60
Image Searching in Auto Sort Mode	61
Displaying Pictures in Auto Sort Mode	61
Using Auto Sort Mode	63
Auto Sort Menu	63
Sorting Favorite Pictures (Favorite Pictures Mode)	64
Preparing an Album (Assigning an Icon)	65
Adding Pictures to Albums	66
Viewing Pictures in an Album	67
Removing Pictures from Albums	68
Using Favorite Pictures Mode	69
Favorite Pictures Menu	69
Voice Memos: Recording and Playback	71
Recording Voice Memos	71
Playing Voice Memos	72
Deleting Voice Memos	72
Editing Pictures	73
Enhancing Contrast and Saturation: Quick Retouch	75
Enhancing Brightness and Contrast: D-Lighting	76

Softening Skin Tones: Skin Softening.....	77
Resizing Pictures: Small Picture.....	79
Creating a Cropped Copy: Crop.....	80
🎬 Movies.....	81
Recording Movies.....	81
The Movie Menu.....	82
🎬 Movie Options.....	82
Movie Playback.....	83
Deleting Movie Files.....	83
Connecting to Televisions, Computers and Printers.....	84
Connecting to a TV.....	84
Connecting to a Computer.....	85
Before Connecting the Camera.....	85
Transferring Pictures from the Camera to a Computer.....	86
Connecting to a Printer.....	89
Connecting the Camera to a Printer.....	90
Printing Pictures One at a Time.....	91
Printing Multiple Pictures.....	92
Creating a DPOF Print Order: Print Set.....	95
MENU Shooting, Playback and Setup Menus.....	98
Shooting Options: The Shooting Menu.....	98
Displaying the Shooting Menu.....	98
🔍 Image Mode.....	99
WB White Balance.....	101
📷 Continuous.....	103
ISO ISO Sensitivity.....	104
🎨 Color Options.....	105
[+] AF Area Mode.....	106
Camera Settings that Cannot Be Applied Simultaneously.....	110
Playback Options: The Playback Menu.....	111
Displaying the Playback Menu.....	111
📺 Slide Show.....	113
🗑️ Delete.....	114
🔒 Protect.....	114
🔄 Rotate Image.....	115
📄 Copy.....	115
Basic Camera Setup: The Setup Menu.....	117
Displaying the Setup Menu.....	118
MENU Menus.....	119
🏠 Welcome Screen.....	120
🕒 Date.....	121
📺 Monitor Settings.....	124

Table of Contents

 Date Imprint.....	125
 Vibration Reduction.....	126
 Motion Detection.....	127
 AF Assist.....	128
 Digital Zoom.....	128
 Sound Settings.....	129
 Auto Off.....	129
 Format Memory/  Format Card.....	130
 Language.....	131
 Video Mode.....	131
 Blink Warning.....	132
 Reset All.....	134
 Firmware Version.....	136
<hr/>	
 Using the projector.....	137
Displaying Pictures with the Projector (Projector Mode).....	137
Projecting Pictures.....	137
Projecting Pictures Taken on a Specific Date or Sorted to a Category or Album.....	139
Using Projector Mode.....	140
Projecting Movies.....	141
Projector Slide Show.....	142
Slide Show Options.....	143
The Projector Settings Menu.....	144
Displaying the Projector Settings Menu.....	144
Power Saving.....	145
Auto Off.....	145
Tone Compensation.....	146
<hr/>	
Technical Notes.....	147
Optional Accessories.....	147
Approved Memory Cards.....	147
Image/Sound File and Folder Names.....	148
Caring for the Camera.....	149
Cleaning.....	151
Storage.....	151
Error Messages.....	152
Troubleshooting.....	156
Specifications.....	162
Supported Standards.....	166
Index.....	167

About This Manual

Thank you for your purchase of a Nikon COOLPIX S1000pj digital camera. This manual was written to help you enjoy taking pictures with your Nikon digital camera. Read this manual thoroughly before use, and keep it where all those who use the product will read it.

Symbols and Conventions

To make it easier to find the information you need, the following symbols and conventions are used:



This icon marks cautions, information that should be read before use, to prevent damage to the camera.



This icon marks tips, additional information that may be helpful when using the camera.



This icon marks notes, information that should be read before using the camera.



This icon indicates that more information is available elsewhere in this manual.

Notations

- A Secure Digital (SD) memory card is referred to as a “memory card.”
- The setting at the time of purchase is referred to as the “default setting.”
- The names of menu items displayed in the camera monitor, and the names of buttons or messages displayed on a computer monitor appear in bold.

Screen Samples

In this manual, images are sometimes omitted from monitor display samples so that monitor indicators can be more clearly shown.

Illustrations and Screen Display

Illustrations and text displays shown in this manual may differ from actual display.

Internal Memory and Memory Cards

Pictures taken with this camera can be stored in the camera’s internal memory or on removable memory cards. If a memory card is inserted, all new pictures will be stored on the memory card and delete, playback and format operations will apply only to the pictures on the memory card. The memory card must be removed before the internal memory can be formatted or accessed for picture storage, deletion, or viewing.

Information and Precautions

Life-Long Learning

As part of Nikon's "Life-Long Learning" commitment to ongoing product support and education, continually updated information is available online at the following sites:

- For users in the U.S.A.: <http://www.nikonusa.com/>
- For users in Europe and Africa: <http://www.europe-nikon.com/support/>
- For users in Asia, Oceania, and the Middle East: <http://www.nikon-asia.com/>

Visit these sites to keep up-to-date with the latest product information, tips, answers to frequently asked questions (FAQs), and general advice on digital imaging and photography. Additional information may be available from the Nikon representative in your area. Visit the site below for contact information.

<http://imaging.nikon.com/>

Use Only Nikon Brand Electronic Accessories

Nikon COOLPIX cameras are designed to the highest standards and include complex electronic circuitry. Only Nikon brand electronic accessories (including battery chargers, batteries and AC adapters) certified by Nikon specifically for use with this Nikon digital camera are engineered and proven to operate within the operational and safety requirements of this electronic circuitry.

THE USE OF NON-NIKON ELECTRONIC ACCESSORIES COULD DAMAGE THE CAMERA AND MAY VOID YOUR NIKON WARRANTY.

The use of third-party rechargeable Li-ion batteries not bearing the Nikon holographic seal could interfere with normal operation of the camera or result in the batteries overheating, igniting, rupturing, or leaking.

For more information about Nikon brand accessories, contact a local authorized Nikon dealer.



Holographic seal:

Identifies this device as an authentic Nikon product.

Before Taking Important Pictures

Before taking pictures on important occasions (such as at weddings or before taking the camera on a trip), take a test shot to ensure that the camera is functioning normally. Nikon will not be held liable for damages or lost profits that may result from product malfunction.

About the Manuals

- No part of the manuals included with this product may be reproduced, transmitted, transcribed, stored in a retrieval system, or translated into any language in any form, by any means, without Nikon's prior written permission.
- Nikon reserves the right to change the specifications of the hardware and software described in these manuals at any time and without prior notice.
- Nikon will not be held liable for any damages resulting from the use of this product.
- While every effort was made to ensure that the information in these manuals is accurate and complete, we would appreciate it were you to bring any errors or omissions to the attention of the Nikon representative in your area (address provided separately).

Notice Concerning Prohibition of Copying or Reproduction

Note that simply being in possession of material that was digitally copied or reproduced by means of a scanner, digital camera or other device may be punishable by law.

- **Items prohibited by law from being copied or reproduced**

Do not copy or reproduce paper money, coins, securities, government bonds or local government bonds, even if such copies or reproductions are stamped "Sample." The copying or reproduction of paper money, coins, or securities which are circulated in a foreign country is prohibited. Unless the prior permission of the government was obtained, the copying or reproduction of unused postage stamps or post cards issued by the government is prohibited. The copying or reproduction of stamps issued by the government and of certified documents stipulated by law is prohibited.

- **Cautions on certain copies and reproductions**

The government has issued cautions on copies or reproductions of securities issued by private companies (shares, bills, checks, gift certificates, etc.), commuter passes or coupon tickets, except when a minimum of necessary copies are to be provided for business use by a company. Also, do not copy or reproduce passports issued by the government, licenses issued by public agencies and private groups, ID cards and tickets, such as passes and meal coupons.

- **Comply with copyright notices**

The copying or reproduction of copyrighted creative works such as books, music, paintings, woodcut prints, maps, drawings, movies and photographs is governed by national and international copyright laws. Do not use this product for the purpose of making illegal copies or to infringe copyright laws.

Disposing of Data Storage Devices

Please note that deleting images or formatting data storage devices such as memory cards or built-in camera memory does not completely erase the original image data. Deleted files can sometimes be recovered from discarded storage devices using commercially available software, potentially resulting in the malicious use of personal image data. Ensuring the privacy of such data is the user's responsibility.

Before discarding a data storage device or transferring ownership to another person, erase all data using commercial deletion software, or format the device and then completely refill it with images containing no private information (for example, pictures of empty sky). Be sure to also replace any pictures selected for the welcome screen (📖 120). Care should be taken to avoid injury or damage to property when physically destroying data storage devices.

Parts of the Camera

The Camera Body

Opening the connector cover

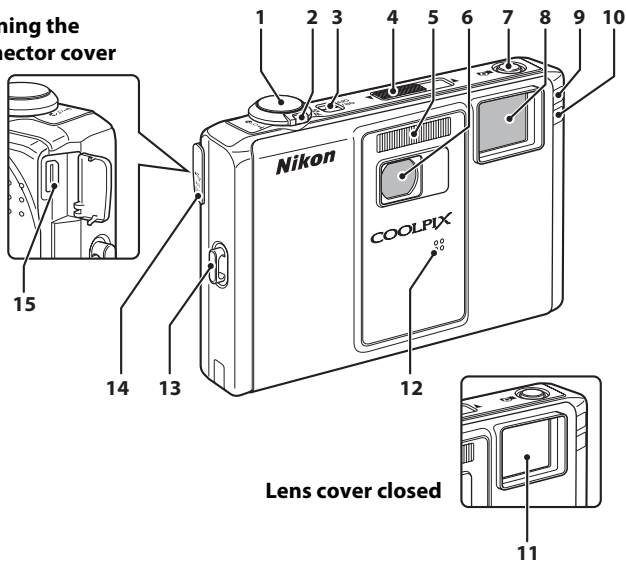

Lens cover closed

1	Shutter-release button.....	26	7	(projector) button.....	137
2	Zoom control.....	25	8	Lens.....	151, 162
	W : wide.....	25	9	Infrared receiver (front).....	35, 138
	T : tele.....	25	10	Self-timer lamp.....	32
	: thumbnail playback.....	54	10	AF-assist illuminator.....	128
	: playback zoom.....	57	11	Lens cover.....	149
3	: help.....	13	12	Built-in microphone.....	71, 81
	Power switch/power-on lamp	17, 22, 129	13	Eyelet for camera strap.....	7
4	Projector focus slider.....	138	14	Connector cover.....	84, 86, 90
5	Built-in flash.....	30	15	Cable connector.....	84, 86, 90
6	Projector window.....	137			

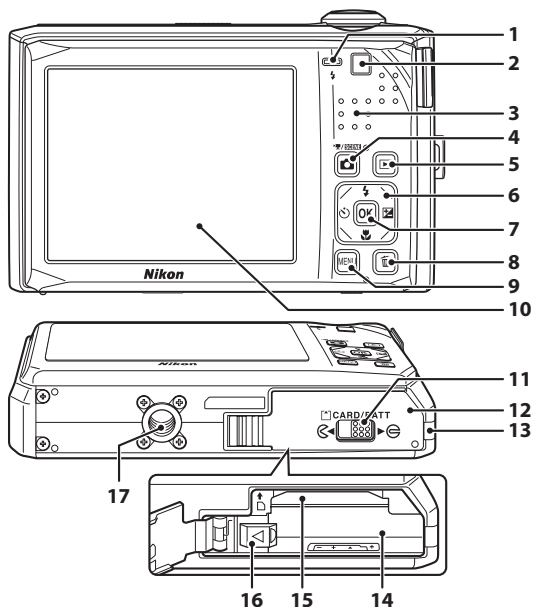

1	Flash lamp.....	31	10	Monitor	8
2	Infrared receiver (rear)	35, 138	11	Cover latch.....	16, 20
3	Speaker	72, 83	12	Battery-chamber/ memory card slot cover	16, 20
4	(shooting mode) button.....	10	13	Power connector cover (for AC adapter; available separately)	147
5	(playback) button	10, 28	14	Battery chamber.....	16
6	Multi selector	11	15	Memory card slot.....	20
7	(apply selection) button	11	16	Battery latch.....	16, 17
8	(delete) button	28, 29, 72, 83	17	Tripod socket	
9	MENU button.....	12, 98, 111, 118, 142, 144			

Remote Control ML-L4

The supplied remote control can be used to take still pictures and to start and end movie recording (📖 35). In projector mode (📖 137), the remote control can be used to change the projected still pictures and to play back movies.

Before using the remote control for the first time, remove the insulating sheet by pulling it in the direction indicated.

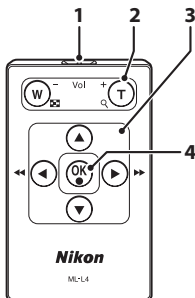
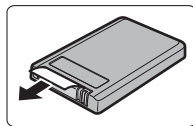

1 Infrared emitter

Zoom button (shooting mode)

W: wide

T: tele

2

Zoom button (projector mode)

: thumbnail playback

: playback zoom

-: decrease volume

+: increase volume

3 Multi selector

4 (apply selection) button

See the following pages for details of the operation of the remote control.

- Shooting mode: "Taking Pictures with the Remote Control" (📖 35)
- Projector mode: "Displaying Pictures with the Projector (Projector Mode)" (📖 137), "Projector Slide Show" (📖 142)

✔ Notes on the Remote Control Battery

- When changing the remote control battery, be sure that the battery's positive (+) and negative (-) terminals are oriented correctly.
- Be sure to read and follow the warnings for the battery on page iii and the section, "The Battery" (📖 150).

Replacing the Remote Control Battery

①

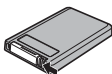

Push the tab in the direction indicated above.

②

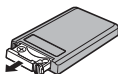

Continue pushing the tab and pull the battery holder out as indicated above.

③



Remove the used 3V CR2025 lithium battery.

④



Place a new 3V CR2025 lithium battery in the battery holder. Be sure that the "+" mark is facing up.

⑤

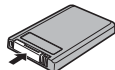

Insert the battery holder into the remote control.

Attaching the Camera Strap

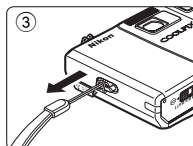
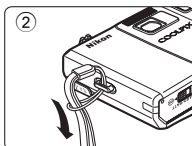
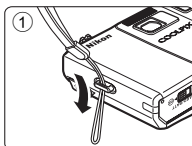

The projector stand can be attached to the camera strap.

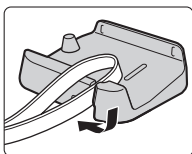

✔ Note on the Projector Stand

Do not carry the camera by the projector stand attached to the camera strap. Should the projector stand slip off the camera strap, the camera could fall.

The Monitor

The following indicators may appear in the monitor during shooting and playback (actual display varies with current camera settings).

The indicators that appear in the monitor during shooting and playback disappear after a few seconds (📖 124).

Shooting

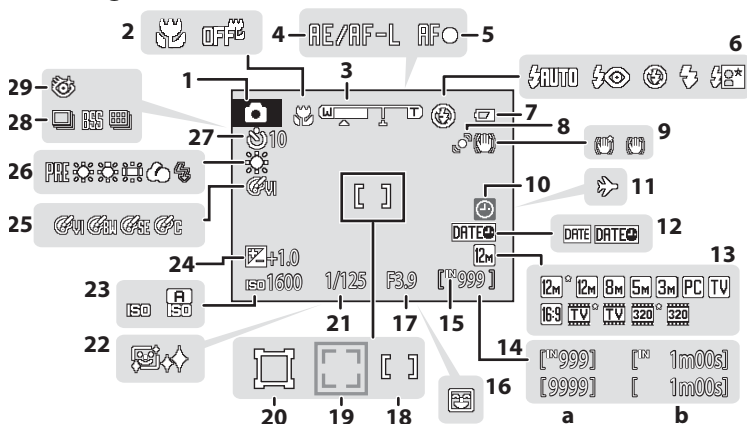

1 Shooting mode *	22, 36, 49, 52, 81	15 Internal memory indicator.....	23
2 Macro mode	33	16 Smile timer.....	49, 51
3 Zoom indicator.....	25, 33	17 Aperture	26
4 AE/AF-L indicator	48	18 Focus area	26, 106
5 Focus indicator	26	19 Focus area (face priority).....	26, 49, 106
6 Flash mode.....	30	20 Focus area (subject tracking mode)	52
7 Battery level indicator	22	21 Shutter speed	26
8 Motion detection icon	23, 127	22 Skin softening	49, 51
9 Vibration reduction icon.....	23, 126	23 ISO sensitivity.....	31, 104
10 "Date not set" indicator	152	24 Exposure compensation value	34
11 Travel destination.....	121	25 Color options	105
12 Date imprint	125	26 White balance mode.....	101
13 Image mode.....	99	27 Self-timer indicator	32
14 Movie options	82	28 Continuous shooting mode	103
a Number of exposures remaining		29 Blink proof icon.....	51
(still pictures).....	22		
b Movie length.....	81		

* Differs according to the current shooting mode.

Playback

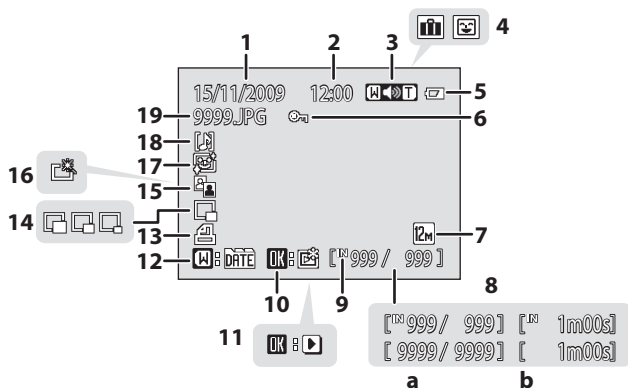

1	Date of recording.....	18	9	Internal memory indicator.....	28
2	Time of recording.....	18	10	Add to favorites guide.....	66
3	Volume indicator.....	72, 83, 142	11	Movie playback guide.....	83
4	Category icon in auto sort mode ¹	61	12	List by date guide.....	58
	Album icon in favorite pictures mode ¹	67	13	Print set icon.....	95
5	Battery level indicator.....	22	14	Small picture icon.....	79
6	Protect icon.....	114	15	D-Lighting icon.....	76
7	Image mode ²	99	16	Quick retouch icon.....	75
	Movie options ²	82	17	Skin softening icon.....	77
8	a Current frame number/ total number of frames.....	28	18	Voice memo icon.....	72
	b Movie length.....	83	19	File number and type.....	148



¹ The icon for the selected category in auto sort mode or the album currently selected in playback mode is displayed.

² Differs according to the settings configured during shooting.

Basic Operations

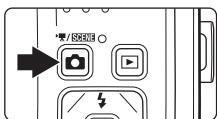
The (Shooting Mode) Button









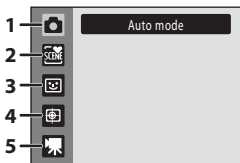



- Press the  button in playback mode or projector mode to enter shooting mode.
- Press the  button in shooting mode to display the shooting-mode selection menu and switch shooting modes.

The Shooting-mode Selection Menu

Use the multi selector ( 11) to select the following shooting modes.







1.  (auto) mode ( 22)
2.  Scene mode* ( 36)
3.  Smart portrait mode ( 49)
4.  Subject tracking mode ( 52)
5.  Movie mode ( 81)

* The icon displayed differs depending upon the last scene mode selected.

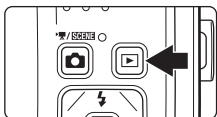
When the  button is pressed with shooting-mode selection menu displayed, monitor display returns to shooting mode without switching shooting mode.

The (Playback) Button











- Press the  button in shooting mode or projector mode to enter playback mode.
- Press the  button in playback mode to display the playback-mode selection menu and switch playback modes.
- If the camera is turned off, hold down the  button to turn the camera on in playback mode.

The Playback-mode Selection Menu

Use the multi selector ( 11) to select the following playback modes.



1.  Playback mode ( 28)
2.  Favorite pictures mode ( 64)
3.  Auto sort mode ( 61)
4.  List by date mode ( 58)

When the  button is pressed with playback-selection menu displayed, monitor display returns to playback mode without switching playback mode.

The Multi Selector

This section describes standard uses of the multi selector to select modes, select menu options and to apply selection.

Shooting

Display  (flash mode) (book 30) menu or
move cursor up

Display  (self-timer)
(book 32) menu



Display  (exposure compensation)
(book 34) guide

Apply selection

Display  (macro mode) (book 33) menu or
move cursor down

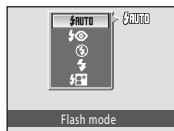

Playback/Projecting

Select previous
picture



Select next picture

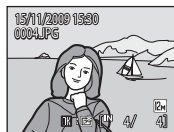

Menu Screen

Move cursor up

Move cursor left
or return to the
previous screen



Move cursor right or go
to next screen (apply
selection)

Apply selection (go to
the next screen)

Move cursor down

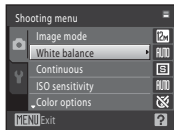

Note on the Multi Selector

In the manual, the button indicating up, down, left and right of the multi selector is shown as ▲, ▼, ◀ and ▶.

The MENU Button

Press the **MENU** button to display the menu for the selected mode.

- Use the multi selector to navigate the menus (11).
- Choose a tab on the left to switch to the menu of the selected tab.
- Press the **MENU** button again to exit the menu.

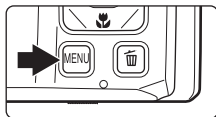

Top tab: Display the available menus in the current mode

Bottom tab: Display the setup menu or projector settings menu

Displayed when the menu contains two or more pages

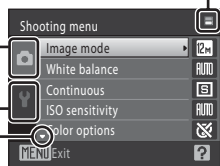

Displayed when there are one or more menu items to follow

Displayed when previous menu items are available



Choose an option and press the **OK** button or the multi selector **▶** to proceed to the next set of options

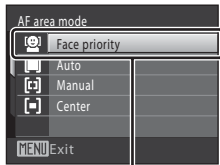

Press the **OK** button or the multi selector **▶** to apply selection

Switching Between Tabs

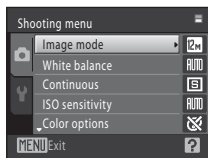

Press the multi selector **◀** to highlight the tab

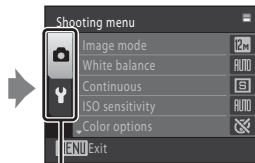

Press the multi selector **▲** or **▼** to select a tab, and press either the **OK** button or **▶**

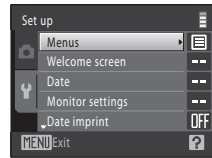

The selected menu is displayed

Help Displays

Rotate the zoom control to **T** (🔍) when **?/🔍** is displayed at the lower right of the menu screen to view a description of the currently selected menu option.

To return to the original menu, rotate the zoom control to **T** (🔍) again.

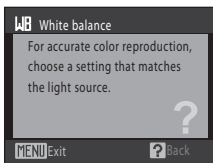
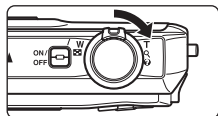

The **🔍** (Projector) Button

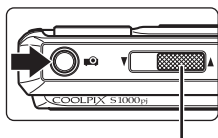

Projector focus slider
(📖 138)

- Press the **🔍** button in shooting mode or playback mode to switch to projector mode.
- Press the **🔍** button again to end projector mode.

Charging the Battery

Charge the Rechargeable Li-ion Battery EN-EL12 (supplied) using the Battery Charger MH-65 (supplied).

- 1 Connect the power cable in the order indicated below.

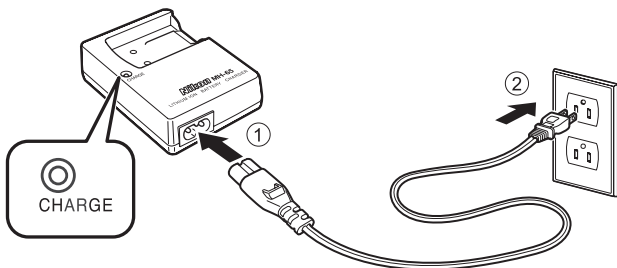

- 2 Insert the battery into the battery charger by sliding the battery forward (1), and press down until it locks into place (2).

- CHARGE lamp starts blinking when charging begins.
- About 2 hours 30 minutes are required to charge a fully exhausted battery.

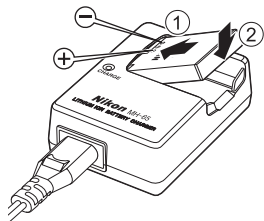

The following chart explains CHARGE lamp status.

CHARGE lamp	Description
Blinks	Battery charging.
On	Battery fully charged.
Flickers	<ul style="list-style-type: none"> The battery is not inserted correctly. Remove the battery and reinsert it into the battery charger so that the battery is lying flat. The ambient temperature is not suited to charging. Charge the battery indoors with an ambient temperature of 5 °C to 35 °C (41 °F to 95 °F) before use. The battery is faulty. Stop charging immediately, unplug the charger, and take both the battery and charger to your retailer or Nikon-authorized service representative.

3 Remove the battery and unplug the charger when charging is complete.

Notes on the Battery Charger

- The supplied battery charger is for use only with the Rechargeable Li-ion Battery EN-EL12.
- Be sure to read and follow the warnings for the battery charger on page iii before using the battery charger.

Notes on the Battery

- Be sure to read and follow the warnings for the battery on page iii and the section, “The Battery” (📖 150), before using the battery.
- If the battery is not used for an extended period, recharge it at least once every six months and completely exhaust it before returning it to storage.

AC Power Supply

To power the camera continuously for extended periods, use an AC Adapter EH-62F (available separately from Nikon; 📖 147). Do not, under any circumstances, use another make or model of AC adapter. Failure to observe this precaution could result in overheating or in damage to the camera.

Inserting the Battery into the Camera

Insert a Rechargeable Li-ion Battery EN-EL12 (supplied) into your camera.

- Charge the battery before the first use or when the battery is running low (📖 14).

1 Open the battery-chamber/memory card slot cover.

Slide the cover latch to the ← side (①) and open (②).

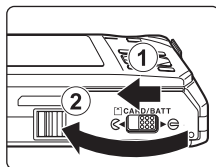

2 Insert the battery.

Confirm that the battery's positive (+) and negative (-) terminals are oriented correctly as shown on the label at the battery chamber opening, and insert the battery.

Use the edge of the battery to push the orange battery latch in the direction indicated by the arrow (①) and fully insert the battery (②).

When the battery is fully inserted, the battery latch will lock it in place.

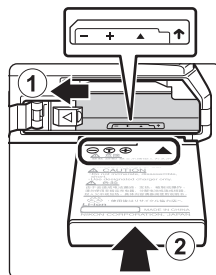

✔ Inserting the Battery

Inserting the battery upside down or backwards could damage the camera. Be sure to check that the battery is in the correct orientation.

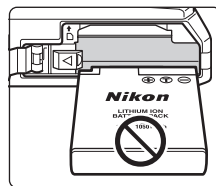

3 Close the battery-chamber/memory card slot cover.

Close the cover (①), and slide the cover latch (②) to the → side.

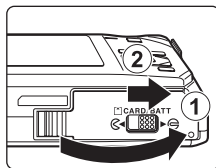

Removing the Battery

Turn the camera off and be sure that the power-on lamp and the monitor have turned off before opening the battery-chamber/memory card slot cover.

To eject the battery, open the battery-chamber/memory card slot cover and slide the orange battery latch in the direction indicated by the arrow (①). The battery can then be removed by hand (②).

- Note that the camera and battery may become hot during use; observe due caution when removing the battery.

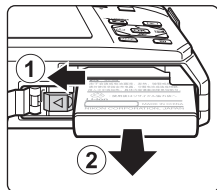



Turning On and Off the Camera

To turn on the camera, press the power switch. The power-on lamp (green) will light for a moment and the monitor will turn on.

To turn off the camera, press the power switch again.

When the camera is turned off, both the power-on lamp and monitor will turn off.

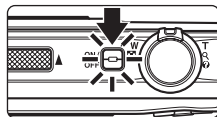

- If the camera is turned off, hold down the  button to turn the camera on in playback mode ( 29).



Auto Power Off in Shooting Mode (Standby Mode)

If no operations are performed for about a minute (default setting), the monitor will turn off automatically and the camera will enter standby mode. If no operations are performed for another three minutes, the camera will turn off automatically (the auto off function).

Pressing the power switch, or the shutter-release button, while the monitor is off in standby mode (power-on lamp is blinking) will reactivate the monitor.

The time allowed to elapse before the camera enters standby mode can be changed from the **Auto off** option ( 129) in the setup menu ( 117).

Setting Display Language, Date and Time

A language-selection dialog is displayed the first time the camera is turned on.

1 Press the power switch to turn on the camera.

The power-on lamp (green) will light for a moment and the monitor will turn on.

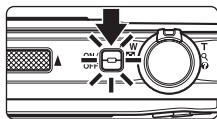

2 Use the multi selector to choose the desired language and press the **OK** button.

For information on using the multi selector, see "The Multi Selector" (📖 11).



3 Choose **Yes** and press the **OK** button.

If **No** is selected, the date and time will not be set.

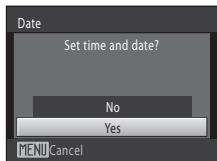

4 Press the multi selector **◀** or **▶** to select your home time zone (📖 123) and press the **OK** button.

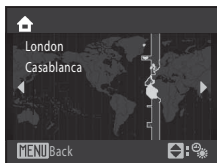

Daylight Saving Time

If daylight saving time is in effect, press the multi selector ▲ in the time zone selection screen displayed in step 4 to turn on the daylight saving time option.

When the daylight saving time option is enabled,  is displayed at the top of the monitor. To turn off the daylight saving time option, press ▼.

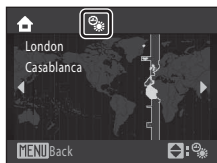

5 Edit the date and time.

Press ▲ or ▼ to edit the highlighted item.

Press ► to move the highlight in the following order.

D (day) → **M** (month) → **Y** (year) → hour → minute → **DMY** (the order in which the day, month, and year are displayed)

Press ◀ to return to the previous item.

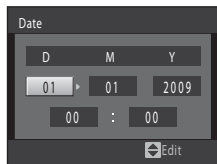

6 Choose the order in which the day, month and year are displayed and press the **OK** button or press ►.

The settings are applied and monitor display exits to shooting mode.

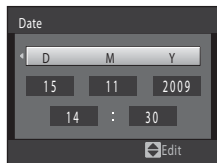

Changing the Date and Time

- Select **Date** from the **Date** item (📖 121) in the setup menu (📖 117) to change the current date and time and follow the procedure described from step 5.
- Select **Time zone** from the **Date** item in the setup menu to change the time zone and daylight saving time settings (📖 121).

Inserting Memory Cards

Image, sound, and movie files are stored in the camera's internal memory (approximately 36 MB) or on removable Secure Digital (SD) memory cards (available separately;  147).

If a memory card is inserted in the camera, data are automatically stored on the memory card and data recorded to the memory card can be played back, deleted or transferred. Remove the memory card to store data in the internal memory, or play back, delete or transfer data from the internal memory.

- 1** Be sure the power-on lamp and the monitor are off and open the battery-chamber/memory card slot cover.

Be sure to turn off the camera before opening the battery-chamber/memory card slot cover.

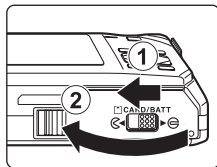

- 2** Insert the memory card.

Slide the memory card in correctly until it clicks into place.

Close the battery-chamber/memory card slot cover.

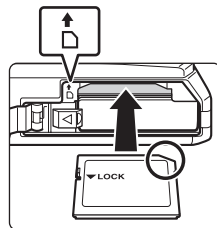

Inserting Memory Cards

Inserting the memory card upside down or backwards could damage the camera or the memory card. Be sure to check that the memory card is in the correct orientation.

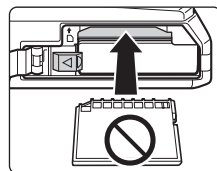

Removing Memory Cards

Before removing memory cards, turn the camera off and confirm that the power-on lamp and monitor are off. Open the battery-chamber/memory card slot cover and press the card in (1) to partially eject the card. The card can then be removed by hand. Do not attempt to remove the card at an angle (2).

- Note that the camera and battery may become hot during use; observe due caution when removing the battery.

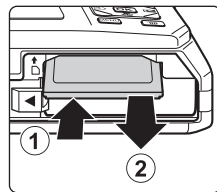

✓ Formatting Memory Cards

If the message at right is displayed, the memory card must be formatted before use (📖 130). Note that **formatting permanently deletes all pictures and other data on the memory card**. Be sure to make copies of any pictures you wish to keep before formatting the memory card.

When formatting the memory card, use the multi selector to choose **Yes** and press the **OK** button. The confirmation dialog will be displayed. To start formatting, choose **Format** and press the **OK** button.

- Do not turn the camera off or open the battery-chamber/memory card slot cover until formatting is complete.
- Be sure to use this camera to format memory cards previously used in other devices the first time they are inserted into the COOLPIX S1000pj (📖 130).

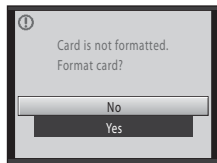

✓ The Write Protect Switch

Memory cards are equipped with a write protect switch. When this switch is in the “lock” position, data cannot be written to, or deleted from, the memory card. If the switch is in the “lock” position, unlock it by sliding the switch to the “write” position to record or delete pictures, or to format the memory card.

Write protect switch

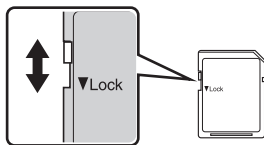

✓ Memory Cards

- Use only Secure Digital memory cards.
- Do not perform the following during formatting, while data is being written to or deleted from the memory card, or during data transfer to a computer. Failure to observe this precaution could result in the loss of data or in damage to the camera or memory card:
 - Take out the battery or memory card
 - Turn off the camera
 - Disconnect the AC adapter
- Do not format the memory card using a computer.
- Do not disassemble or modify.
- Do not drop, bend, or expose to water or strong physical shock.
- Do not touch the metal terminals with your fingers or metal objects.
- Do not affix labels or stickers to the memory card.
- Do not leave in direct sunlight, closed vehicles or areas exposed to high temperatures.
- Do not expose to humidity, dust, or corrosive gases.

Step 1 Turn the Camera On and Select (Auto) Mode

This section describes taking pictures in  (auto) mode, an automatic, “point-and-shoot” mode recommended for first-time users of digital cameras.

1 Press the power switch to turn on the camera.

The power-on lamp (green) will light for a moment and the monitor will turn on.

Proceed to step 4 when  is displayed.

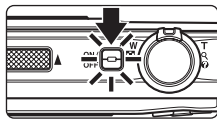

2 Press the button to display the shooting menu.

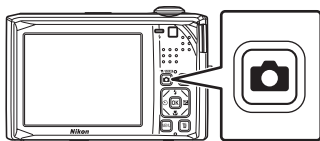

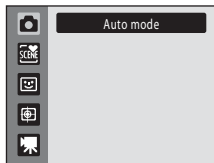

3 Press the multi selector or to choose and press the button.

The camera enters  (auto) mode.



4 Check the battery level and the number of exposures remaining.

Battery Level

Monitor	Description
NO INDICATOR	Battery fully charged.
	Battery low. Prepare to charge or replace the battery.
 Battery exhausted.	Cannot take pictures. Recharge or replace with a fully charged battery.

Battery level indicator

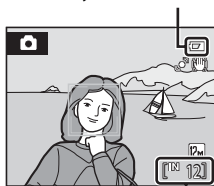



Number of exposures remaining

Number of Exposures Remaining



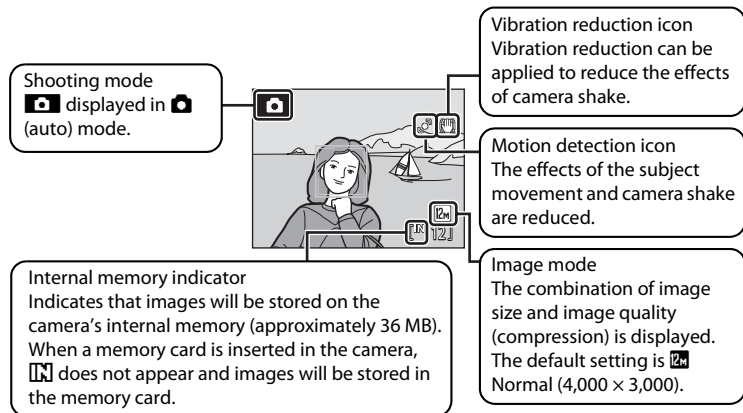



The number of pictures that can be stored depends on the capacity of the internal memory or memory card and image mode setting ( 100).

Indicators Displayed in (Auto) Mode





- The indicators and photo info displayed during shooting and playback will turn off after a few seconds ( 124).
- When the monitor has turned off in standby mode to save power, press the power switch or the shutter-release button to reactivate it ( 129).

Functions Available in (Auto) Mode

In  (auto) mode, the flash mode ( 30) can be selected, macro mode ( 33) and exposure compensation ( 34) can be applied and pictures can be taken using self-timer ( 32). Pressing the **MENU** button in  (auto) mode to specify settings for all shooting menu items ( 98) according to the shooting conditions.

Vibration Reduction and Motion Detection

- See **Vibration reduction** ( 126) or **Motion detection** ( 127) in the setup menu ( 117) for more information.
- Set **Vibration reduction** to **Off** when using a tripod to stabilize the camera during shooting.

Step 2 Frame a Picture

1 Ready the camera.

Hold the camera steadily in both hands, keeping your fingers and other objects away from the lens, flash, the projector button, AF assist-illuminator, microphone, and speaker.

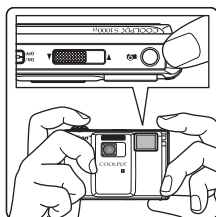

When taking pictures in portrait ("tall") orientation, turn the camera so that the built-in flash is above the lens.

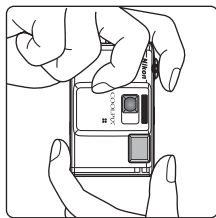

2 Frame the picture.

When the camera recognizes a human face, that face will be framed by a yellow double border (default setting).

Up to 12 faces can be recognized. If more than one face is recognized, the face nearest to the camera will be framed in the focus area by a double border, and the other faces will be framed by a single border.



The focus area is not displayed when taking pictures of subjects other than people, or when framing a picture in which no face is recognized. Frame the picture so that the intended subject is at or near the center of the frame.

Using the Zoom

Use the zoom control to activate optical zoom. Rotate the zoom control to **T** to zoom in so that the subject fills a larger area of the frame, or **W** to zoom out, thus increasing the area visible in the frame.

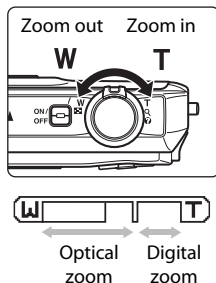

A zoom indicator is displayed at the top of the monitor when the zoom control is rotated.

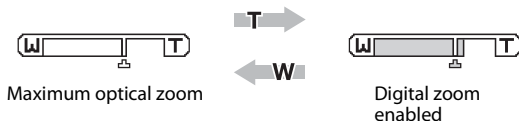

Digital Zoom

When the camera is zoomed in to the maximum optical zoom position, rotating and holding the zoom control at **T** triggers digital zoom. The subject is magnified up to 4× the maximum optical zoom ratio. The camera focuses at the center of the frame and the focus area is not displayed when digital zoom is in effect.



Digital Zoom and Interpolation

Unlike optical zoom, digital zoom uses a digital imaging process known as interpolation to magnify images, resulting in slight deterioration of picture quality.

Interpolation is applied at zoom positions beyond . When zoom is increased beyond the  position, interpolation is initiated and the zoom indicator turns yellow to indicate that interpolation is being applied. The position of  moves to the right as image size decreases, allowing for confirmation of the zoom positions at which shooting without interpolation is possible at the current image mode setting.



Digital zoom can be disabled from the **Digital zoom** option ( 128) in the setup menu ( 117).

Step 3 Focus and Shoot

1 Press the shutter-release button halfway.

Press the shutter-release button halfway (📖 27) to focus.

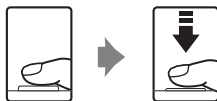

When a face is recognized, it is framed by the double border indicating the active focus area. When the subject is in focus, the double border turns green.



Shutter speed Aperture

When a face is not recognized, camera automatically selects the focus area (one of nine) containing the subject closest to the camera. When the subject is in focus, the active focus area glows green.

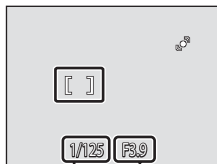

Shutter speed Aperture

When digital zoom is used, the focus area is not displayed and the camera focuses at the center of the frame. Once focus has been acquired, the focus indicator (📖 8) turns green.

When the shutter-release button is pressed halfway, the shutter speed and aperture values also appear.

Focus and exposure remain locked while the shutter-release button is pressed halfway.

While the shutter-release button is pressed halfway, the focus area or focus indicator may blink red. This indicates that the camera is unable to focus. Modify the composition and press the shutter-release button halfway again.

2 Press the shutter-release button the rest of the way down.

The shutter is released and the picture will be recorded to the memory card or internal memory.



Shutter-release Button

The camera features a two-stage shutter-release button. To set focus and exposure, press the shutter-release button halfway, stopping when you feel resistance. Focus and exposure lock while the shutter-release button is held in this position. To release the shutter and take a picture, press the shutter-release button the rest of the way down. Do not use force when pressing the shutter-release button, as this may result in camera shake and blurred pictures.

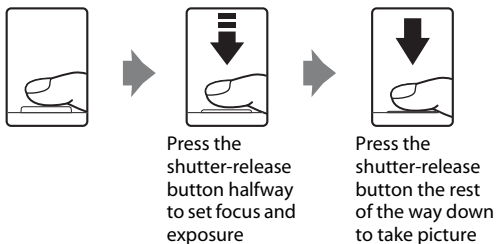

✓ During Recording

While pictures are being recorded, the number of exposures remaining will blink. **Do not open the battery-chamber/memory card slot cover** while pictures are being recorded. Cutting power or removing the memory card in these circumstances could result in loss of data or in damage to the camera or card.

✓ Autofocus

Autofocus may not perform as expected in the following situations. In some rare cases, the subject may not be in focus despite the fact that the focus area or the focus indicator glow green:

- Subject is very dark
- Objects of sharply differing brightness are included in the scene (e.g. the sun behind the subject makes that subject appear very dark)
- No contrast between the subject and surroundings (e.g. a portrait subject, wearing a white shirt, is standing in front of a white wall)
- Several objects are at different distances from the camera (e.g. the subject is inside a cage)
- Subject is moving rapidly

In the situations noted above, try pressing the shutter-release button halfway to refocus several times, or focus on another subject and use focus lock (📖 107). When using focus lock, be sure that the distance between the camera and the subject with which focus was locked is the same as that for the actual subject.

✓ Note on Face Priority

See **AF area mode** (📖 106) and "Face Priority" (📖 108) for more information.

📖 AF-assist Illuminator and Flash









If the subject is poorly lit, the AF-assist illuminator (📖 128) may light by pressing the shutter-release button halfway, or the flash (📖 30) may fire when the shutter-release button is pressed all the way down.

Step 4 Playing Back and Deleting Pictures

Playing Back Pictures (Playback Mode)



Press the  button.

The last picture taken will be displayed in full-frame playback mode.

Press the multi selector , ,  or  to view additional pictures. Continue holding down the multi selector , ,  or  to cycle quickly through pictures.

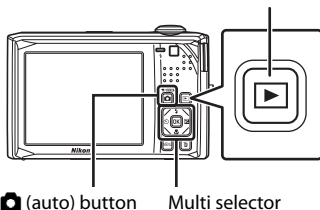
 (playback) button



When playing back pictures stored on the camera's internal memory,  is displayed. When a memory card is inserted in the camera,  is not displayed and images stored on the memory card are played back.

Press the  button or the shutter-release button to switch to shooting mode.

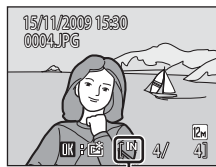

Internal memory indicator

Deleting Pictures

- 1 Press the  button to delete the picture currently displayed in the monitor.

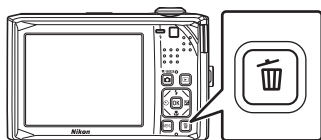

- 2 Use the multi selector to select **Yes** and press the  button.





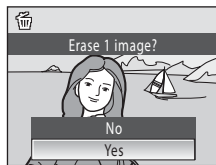







Deleted pictures cannot be restored.

To exit without deleting the picture, choose **No** and press the  button.



Options Available in Playback Mode





The following options are available in full-frame playback mode.

Option	Use	Description	
Playback zoom	T 	Rotate the zoom control to T to enlarge the picture up to 10×. Press the  button to return to full-frame playback mode.	57
View thumbnails/ apply calendar display	W 	Rotate the zoom control to W to display 4, 9 or 16 picture thumbnails or to apply the calendar display.	54
Add favorite pictures		Add the picture currently displayed to albums.	66
Switch to playback mode		Press the  button to display the playback-mode selection menu and change to list by date, auto sort, or favorite pictures mode.	58, 61, 67
Switch to shooting mode		Press the  button or the shutter-release button to switch back to the current shooting mode.	28
	 		
Switch to projector mode		Project pictures with the built-in projector.	137

Pressing the Button to Turn On the Camera

When the camera is off, holding down the  button will turn the camera on in playback mode.

Viewing Pictures



- Pictures stored in the internal memory can only be viewed if no memory card is inserted.
- When pictures in which a face was recognized during shooting ( 108) are displayed in full-frame playback, depending upon the orientation of the recognized face, the pictures may be automatically rotated for playback display except pictures taken with **Continuous**, **BSS**, and **Multi-shot 16** setting ( 103).
- When the monitor has turned off in standby mode to save power, press the  button or the power switch to reactivate it ( 129).

Deleting the Last Picture Taken While in Shooting Mode

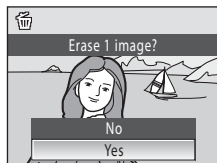
In shooting mode, press the  button to delete the last picture taken.



Deleting Multiple Pictures

Multiple pictures can be deleted from the **Delete** option ( 114) in the playback menu ( 111), the list by date menu ( 60), the auto sort menu ( 63), or the favorite pictures menu ( 69).

Using the Flash

The flash has a range of 0.3–3.5 m (1–11 ft.) when the camera is zoomed out all the way. With maximum optical zoom applied, the range is 0.5–2.5 m (1–8 ft.) when **ISO sensitivity** is set to **Auto**. The following flash modes are available.



Auto

Flash fires automatically when lighting is poor.



Auto with red-eye reduction

Reduce “red-eye” in portraits (📖 31).



Off

Flash will not fire even when lighting is poor.



Fill flash

Flash fires whenever a picture is taken. Use to “fill-in” (illuminate) shadows and backlit subjects.



Slow sync

⚡AUTO (auto) is combined with slow shutter speed.

Flash illuminates main subject; slow shutter speeds are used to capture background at night or under dim lighting.

Setting the Flash Mode

- 1 Press **⚡** (flash mode).

The flash menu is displayed.



- 2 Press the multi selector **▲** or **▼** to choose the desired flash mode and press the **OK** button.

The icon for the selected flash mode is displayed at the top of the monitor.

When **⚡AUTO** (auto) is applied, **⚡AUTO** is only displayed for a few seconds, regardless of **Photo info** settings (📖 124).

If a setting is not applied by pressing the **OK** button within a few seconds, the selection will be cancelled.

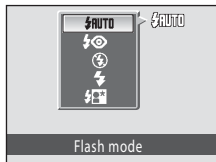

✓ Shooting When the Flash is Disabled (🚫) or Lighting is Poor

- Use of a tripod is recommended to stabilize the camera during shooting and avoid the effects of camera shake. Set **Vibration reduction** (📖 126) to **Off** in setup menu (📖 117) when using a tripod to stabilize the camera during shooting.
- The **ISO** indicator is displayed when the camera automatically increases sensitivity. Pictures taken when **ISO** is displayed may be slightly mottled.

✓ Notes on the Flash

- When using the flash, reflections from dust particles in the air may appear as bright spots in pictures. To reduce these reflections, set the flash to 🚫 (off).
- There may be functions with which the flash cannot be enabled. See “Camera Settings that Cannot Be Applied Simultaneously” (📖 110) for more information.

📎 The Flash Lamp

The flash lamp indicates flash status when the shutter-release button is pressed halfway.

- On: Flash will fire when picture is taken.
- Blinks: Flash charging. Wait a few seconds and try again.
- Off: Flash will not fire when picture is taken.

If the battery is low, the monitor display will turn off, and remain off, until the flash is fully charged.

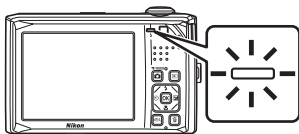

📎 The Flash Mode Setting

The default flash mode setting varies with shooting mode.

- 📷 (auto): **🚫AUTO** (auto)
- Scene: varies with the selected scene mode (📖 37–42)
- 📸 (smart portrait): fixed at 🚫 (off) when **On** is selected for **Blink proof**, **🚫AUTO** (auto) when **Off** is selected for **Blink proof** (📖 51)
- 📷 (subject tracking): **🚫AUTO** (auto)

The flash mode setting applied in 📷 (auto) mode is stored in the camera's memory even after the camera is turned off, and reapplied the next time 📷 (auto) mode is selected.

📎 Red-eye Reduction

This camera uses advanced red-eye reduction (“In-Camera Red-Eye Fix”). The flash fires several times at low intensity (pre-flash) before the main flash, reducing “red eye.” The camera then analyzes the picture; if red-eye is detected, the affected area will be processed to further reduce red-eye before the picture is saved. Please note the followings.

- There is a slight lag between the shutter-release button being pressed and the picture being shot because of the pre-flash. This mode is not recommended when a quick shutter response is required.
- The time before the next picture can be taken increases slightly.
- Advanced red-eye reduction may not produce the desired results in all situations.
- In extremely rare instances, areas not subject to red-eye may be affected by advanced red-eye reduction processing; in these cases, choose another mode and try again.

Taking Pictures with the Self-timer

The camera is equipped with a ten-second and two-second timer for self-portraits. This feature is useful for reducing the effects of camera shake that occurs when pressing the shutter-release button.

When using the self-timer, use of a tripod is recommended. Set **Vibration reduction** (📖 126) to **Off** in the setup menu (📖 117) when using a tripod to stabilize the camera during shooting.

1 Press (self-timer).

The self-timer menu is displayed.



2 Press the multi selector or to choose **10 s** or **2 s** and press the button.

10 s (ten seconds): Use on important occasions, such as weddings

2 s (two seconds): Use to prevent camera shake

The mode selected for self-timer is displayed.

If a setting is not applied by pressing the  button within a few seconds, the selection will be cancelled.

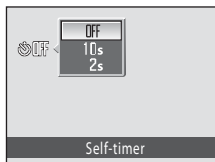

3 Frame the picture and press the shutter-release button halfway.

Focus and exposure will be set.



4 Press the shutter-release button the rest of the way down.

The self-timer starts, and the number of seconds remaining before the shutter is released is displayed in the monitor. The self-timer lamp blinks while the timer is counting down. About one second before the shutter is released, the lamp stops blinking and glows steadily.

When the shutter is released, the self-timer will be set to **OFF**.

To stop the timer before a picture is taken, press the shutter-release button again.

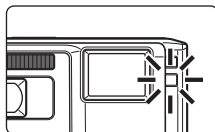
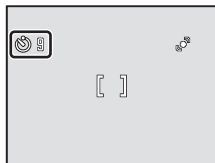

Macro Mode

Macro mode is used for taking pictures of objects as close as 3 cm (1.2 in.). Note that the flash may be unable to light the entire subject at distances of less than 30 cm (1 ft.).

1 Press (macro mode).

The macro menu is displayed.





2 Press the multi selector or to choose **ON** and press the button.

The macro mode icon () is displayed.

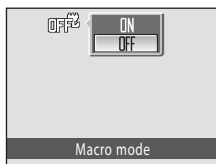
If a setting is not applied by pressing the  button within a few seconds, the selection will be cancelled.



3 Rotate the zoom control to frame the picture.



The camera can focus at a distance of 3 cm (1.2 in.) at the zoom position at which  and the zoom indicator glow green (the zoom indicator is positioned to the left of ).



Autofocus

In macro mode, the camera focuses continuously until focus is locked when the shutter-release button is pressed halfway. Therefore, the sound of lens drive movement can be heard.

The Macro Mode Setting

The macro mode setting applied in  (auto) mode is stored in the camera's memory even after the camera is turned off, and reapplied the next time  (auto) mode is selected.

Exposure Compensation

Exposure compensation is used to alter exposure from the value suggested by the camera to make pictures brighter or darker.

1 Press (exposure compensation).

The exposure compensation guide is displayed.



2 Press the multi selector or to adjust exposure and press the button.

When the picture is too dark, adjust the exposure compensation to “+” direction.

When the picture is too bright, adjust the exposure compensation to “-” direction.

Exposure compensation can be set to values between -2.0 and +2.0 EV.

If a setting is not applied by pressing the  button within a few seconds, the selection will be cancelled.

When an exposure compensation value other than **0.0** is applied, the value is displayed with the  indicator in the monitor.

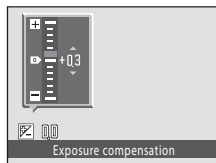



3 Press the shutter-release button to take a picture.

To exit without altering exposure, return to step 1, change the value to **0.0** and press the  button.



Exposure Compensation Value

The exposure compensation value applied in  (auto) mode is stored in the camera's memory even after the camera is turned off, and reapplied the next time  (auto) mode is selected.

Using Exposure Compensation

The camera tends to reduce exposure when the frame is dominated by brightly lit objects and to increase exposure when the frame is mostly dark. *Positive* compensation may therefore be required to capture the brilliancy of very bright objects that fill the frame (for example, sunlit expanses of water, sand, or snow) or when the background is much brighter than the main subject. *Negative* compensation may be called for when large areas of the frame contain very dark objects (for example, a swath of dark green leaves) or when the background is much darker than the main subject.

Taking Pictures with the Remote Control

Use the remote control ML-L4 (supplied;  6) to take pictures. It is convenient for taking self-portraits and effectively eliminates blur caused by camera shake that occurs when the shutter-release button is pressed.

- The remote control can also be used in conjunction with the self-timer.
- When recording movies, use the remote control to start and stop movie recording.
- Use of a tripod is recommended during shooting with the remote control. In this situation, set **Vibration reduction** ( 126) to **Off** when using a tripod during shooting.

1 Use a tripod or other means of stabilizing the camera.

2 Frame a picture.

To use the self-timer, follow steps 1 and 2 under “Taking Pictures with the Self-timer” ( 32) to apply self-timer settings.

To record movies, follow step 1 under “Recording Movies” ( 81) to switch shooting mode to movie mode.

Press the **T** or **W** button to activate the zoom. Press the **T** button to zoom in so that the subject fills a larger area of the frame, or the **W** button to zoom out, thus increasing the area visible in the frame. See “Recording Movies” ( 81) for details on using zoom with movie recording.

When **Smile timer** is set to **On** in smart portrait mode ( 49), and the camera recognizes human faces, remote control operation is not available.

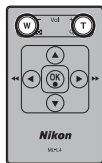

3 Point the remote control at the infrared receiver on the front or rear of the camera (4, 5) and press the button.

The shutter is released and a picture is saved.

Do not exceed more than approximately 5 m (16 ft.) from the camera.

When the self-timer is used, focus is locked, exposure is adjusted, and the self-timer begins counting down. Once the shutter is released, the self-timer is automatically disabled. To stop the self-timer before a picture is taken, press the  button again.

In movie mode, movie recording starts. Press the  button again to stop recording.

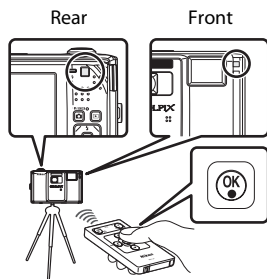

Shooting in Scene Mode

Camera settings are automatically optimized for the selected subject type. The following scene modes are available.

Scene auto selector	Portrait	Landscape	Sports	Night portrait
Party/indoor	Beach/snow	Sunset	Dusk/dawn	Night landscape
Close-up	Food	Museum	Fireworks show	Copy
Backlight	Panorama assist			

Selecting a Scene Mode

- 1 Press the button in shooting mode to display the shooting-mode selection menu and press the multi selector or to select a scene icon.

The icon for the last scene mode selected is displayed. The default setting is (Scene auto selector).



- 2 Press the multi selector and press , , , or to choose the desired scene, and then press the button.

The display changes to that for the selected scene mode.

See “Features” (37) for more information.

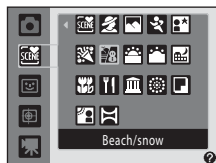

- 3 Frame the subject and take a picture.





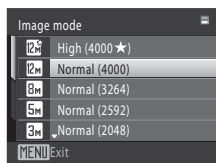

Image Mode

When the **MENU** button is pressed in scene mode, **Image mode** (99) can be adjusted. Change made to this setting applies to all shooting modes (except for movie mode).



Features

The following icons are used for descriptions in this section: , flash mode (📖 30); , self-timer (📖 32); , macro mode (📖 33); , exposure compensation (📖 34).

Scene auto selector

By simply framing a picture, the camera automatically selects the optimum scene mode. See “Shooting in the Scene Mode Selected by the Camera (Scene Auto Selector)” (📖 43) for more information.



¹ The camera automatically selects the optimum flash mode for the scene mode it has selected. Can be changed to  (off).

² Default setting can be modified.

³ Switched to ON when the camera selects **Close-up** scene mode.

Portrait

Use this mode for portraits.

- The camera recognizes and focuses on a human face. See “Face Priority” (📖 108) for more information.
- If more than one face is recognized, focus will be on the face nearest to the camera.
- The camera softens skin tones (in up to three faces) by applying the skin softening function before recording pictures (📖 50).
- If no faces are recognized, the camera focuses on the subject at the center of the screen by pressing the shutter-release button halfway.
- Digital zoom is not available.



* Default setting can be modified.

Landscape

Use this mode for vivid landscapes and cityscapes.

- Camera focuses at infinity. The focus area or focus indicator (📖 8) always glows green when the shutter-release button is pressed halfway. Note, however, that objects in the foreground may not always be in focus.
- AF-assist illuminator (📖 128) does not light.





* Default setting can be modified.

Shooting in Scene Mode

Sports

Use this mode for dynamic action shots that freeze the action in a single shot and record motion in a series of pictures.

- The camera focuses on the subject at the center of the frame and focuses continuously until focus is locked by pressing the shutter-release button halfway.
- While the shutter-release button is held down, up to 4 pictures are taken at a rate of about 0.9 frames per second (fps) when **Image mode** is set to  **Normal (4000)**.
- Focus, exposure and white balance are fixed at the values determined with the first picture in each series.
- AF-assist illuminator ( 128) does not light.
- The maximum frame rate with continuous shooting may vary depending upon the current image mode setting, the memory card used, or shooting condition.





			Off		Off		0.0*
---	---	---	-----	---	-----	---	------

* Default setting can be modified.

Night portrait



Use this mode for portraits taken at sunset or at night. The flash fires to light the portrait subject while preserving background lighting to achieve a natural balance between the main subject and background ambience.



- The camera recognizes and focuses on a human face. See "Face Priority" ( 108) for more information.
- If more than one face is recognized, focus will be on the face nearest to the camera.
- The camera softens skin tones (in up to three faces) by applying the skin softening function before recording pictures ( 50).
- If no faces are recognized, the camera focuses on the subject at the center of the screen by pressing the shutter-release button halfway.
- Digital zoom is not available.



	 ¹		Off ²		Off		0.0 ²
---	--	---	------------------	---	-----	---	------------------

¹ Fill flash with slow sync and red-eye reduction.

² Default setting can be modified.

 Use of a tripod is recommended in scene modes with which  is indicated. Set **Vibration reduction** ( 126) to **Off** when using a tripod to stabilize the camera.

NR: Noise reduction is automatically performed in scene modes with which  is indicated. More time than usual is required to save pictures to which noise reduction is applied.

Party/indoor

Captures the effects of candlelight and other indoor background lighting.

- Camera focuses on subject at the center of the frame.
- As pictures are easily affected by camera shake, hold the camera steadily. In dark surroundings, the use of a tripod is recommended. Set **Vibration reduction** (📖 126) to **Off** when using a tripod to stabilize the camera.



¹ Slow sync with red-eye reduction flash mode may be used. The default setting can be modified.

² Default setting can be modified.

Beach/snow

Captures the brightness of such subjects as snowfields, beaches, or sunlit expanses of water.

- Camera focuses on subject at the center of the frame.



* Default setting can be modified.

Sunset

Preserves the deep hues seen in sunsets and sunrises.

- Camera focuses on subject at the center of the frame.



* Default setting can be modified.

Dusk/dawn

Preserves the colors seen in the weak natural light before sunrise or after sunset.

- Camera focuses at infinity. The focus area or focus indicator (📖 8) always glows green when the shutter-release button is pressed halfway. Note, however, that objects in the foreground may not always be in focus.
- AF-assist illuminator (📖 128) does not light.





* Default setting can be modified.

Shooting in Scene Mode

Night landscape



Slow shutter speeds are used to produce stunning night landscapes.

- Camera focuses at infinity. The focus area or focus indicator () always glows green when the shutter-release button is pressed halfway. Note, however, that objects in the foreground may not always be in focus.
- AF-assist illuminator () does not light.









			Off*		Off		0.0*
---	---	---	------	---	-----	---	------

* Default setting can be modified.

Close-up



Photograph flowers, insects and other small objects at close range.



- Macro mode () is enabled and the camera automatically zooms to the closest position at which it can focus.
- The closest possible shooting distance may vary according to the zoom position. The camera can focus at distance of 3 cm (1.2 in.) at the zoom position at which  and the zoom indicator glow green (the zoom indicator is positioned to the left of ).
- **AF area mode** is set to **Manual** () (106). Press the  button to choose the focus area in which the camera focuses.
- The camera focuses continuously until focus is locked by pressing the shutter-release button halfway.
- As pictures are easily affected by camera shake, be sure that **Vibration reduction** () (126) is enabled and hold the camera steadily.



			Off*		On		0.0*
---	---	---	------	---	----	---	------

* Default setting can be modified. Note that the flash may be unable to light entire subject at distances of less than 30 cm (1 ft.).

 Use of a tripod is recommended in scene modes with which  is indicated. Set **Vibration reduction** () to **Off** when using a tripod to stabilize the camera.

 Noise reduction is automatically performed in scene modes with which  is indicated. More time than usual is required to save pictures to which noise reduction is applied.

🍴 Food

Use when taking pictures of food. See “Taking Pictures in Food Mode” (📖 45) for details.

- **AF area mode** is set to **Manual** (📖 106). Press the **OK** button to choose the focus area in which the camera focuses.



* Default setting can be modified.

🏛️ Museum

Use indoors where flash photography is prohibited (for example, in museums and art galleries) or in other settings in which you do not want to use the flash.

- Camera focuses on subject at the center of the frame.
- BSS (best shot selector) can be enabled (📖 103).
- As pictures are easily affected by camera shake, be sure that **Vibration reduction** (📖 126) is enabled and hold the camera steadily.
- AF-assist illuminator (📖 128) does not light.



* Default setting can be modified.

🎆 Fireworks show



Slow shutter speeds are used to capture the expanding burst of light from a firework.

- Camera focuses at infinity. The focus indicator (📖 8) always glows green when the shutter-release button is pressed halfway. Note, however, that objects in the foreground may not always be in focus.
- AF-assist illuminator (📖 128) does not light.



Shooting in Scene Mode

Copy

Provides clear pictures of text or drawings on a white board or in print.

- Camera focuses on subject at the center of the frame.
- Use macro mode (📖 33) to focus at short ranges.
- Colored text and drawings may not show up well.

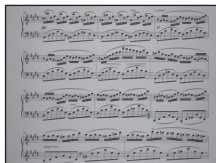

* Default setting can be modified.

Backlight

Use when light is coming from behind the subject, throwing features or details into shadow. The flash fires automatically to “fill in” (illuminate) shadows.

- Camera focuses on subject at the center of the frame.



* Default setting can be modified.

Panorama assist



Use when taking a series of pictures that will later be joined to form a single panorama using the supplied Panorama Maker software. See “Shooting for a Panorama” (📖 47) for details.











* Default setting can be modified.

Shooting in the Scene Mode Selected by the Camera (Scene Auto Selector)

By simply framing a picture, the camera automatically selects the optimum scene mode for simpler shooting.

When a picture is framed in  (Scene auto selector) mode, the camera automatically adjusts settings for one of the following scene modes:

- Auto (general shooting)
- Portrait ( 37)
- Landscape ( 37)
- Night portrait ( 38)
- Night landscape ( 40)
- Close-up ( 40)
- Backlight ( 42)

- 1 Press the  button in shooting mode to display the shooting-mode selection menu and use the multi-selector to select  (Scene auto selector) mode ( 36).

The camera enters scene auto selector mode.



- 2 Frame the subject and take a picture.

When the camera automatically selects a scene mode, the shooting mode icon changes to that for the scene mode currently enabled.

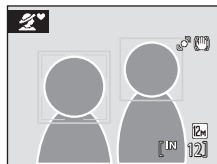

- | | |
|--|---|
|  : Auto |  : Night landscape |
|  : Portrait |  : Close-up |
|  : Landscape |  : Backlight |
|  : Night portrait | |







Press the shutter-release button halfway to set focus and exposure. When the subject is in focus, the active focus area glows green.

Press the shutter-release button the rest of the way down to take the picture.

Note on Scene Auto Selector Mode



Depending upon shooting conditions, the camera may not select the desired scene mode. Should this occur, switch to  (auto) mode ( 22) or select the desired scene mode manually ( 36).

Focusing in Scene Auto Selector Mode

- When the camera recognizes a human face in scene auto selector mode, it focuses on that face. See "Face Priority" ( 108) for more information.
- When the shooting mode indicator  or  is displayed, the camera automatically selects the focus area (one of nine) containing the subject closest to the camera as same as when **Auto** is selected for **AF area mode** ( 106).

Flash Mode in Scene Auto Selector Mode

 AUTO (auto; default setting) and  (off) flash mode settings can be applied ( 30).



- When  AUTO (auto) is applied, the camera automatically selects the optimum flash mode setting for the scene mode it has selected.
- When  (off) is applied, the flash does not fire, regardless of shooting conditions.

Scene Auto Selector Mode Restrictions

- Digital zoom is not available.
- The macro mode button on the multi selector ( 11, 33) is disabled.

Taking Pictures in Food Mode

Use this mode to take pictures of food.

- 1** Press the  button in shooting mode to display the shooting-mode selection menu and use the multi selector to select  (Food) scene mode (📖 36).

Macro mode (📖 33) will be turned on and the camera automatically zooms to the position at the closest distance at which the camera can focus.







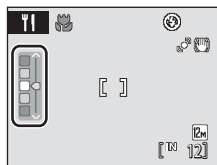



- 2** Press the multi selector  or  to choose white balance.

Press  to increase the amount of red, or  to increase the amount of blue.



- 3** Frame the picture.

The closest possible shooting distance may vary according to the zoom position. The camera can focus at a distance of 3 cm (1.2 in.) at the zoom position at which  and the zoom indicator glow green (the zoom indicator is positioned to the left of ).

AF area mode is set to **Manual** (📖 106). Press the  button to move the focus area. Press the multi selector , , , or  to select a focus area and press the  button again to activate the selected focus area.

Self-timer (📖 32) and exposure compensation (📖 34) settings can be adjusted while the focus area is locked.

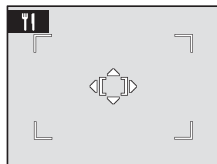
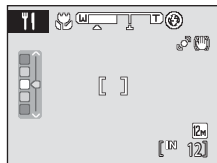

- 4** Press the shutter-release button to take a picture.

Focus is locked when the shutter-release button is pressed halfway, and a picture is taken when the shutter-release button is pressed the rest of the way down.

When the camera is unable to focus, the focus area blinks red. Change the composition and press the shutter-release button halfway again.



Notes on Food Mode



- The flash is disabled. Macro mode setting (📖 33) is fixed at **ON**.
- As pictures are easily affected by camera shake, check the **Vibration reduction** (📖 126) setting and hold the camera steadily.

White Balance Setting in Food Mode

- Increasing the amount of red or blue decreases the effects of lighting.
- Adjusting white balance in food mode has no affect on the shooting menu's **White balance** setting (📖 101).
- Adjustments to white balance applied in food mode are stored in the camera's memory even after the camera is turned off, and reapplied the next time food mode is selected.

Shooting for a Panorama





The camera focuses on the subject at the center of the frame. Use a tripod for the best results. Set **Vibration reduction** (📖 126) to **Off** in setup menu (📖 117) when using a tripod to stabilize the camera.



- 1 Press the  button in shooting mode to display the shooting-mode selection menu and use the multi selector to select  (Panorama assist) scene mode (📖 36).

Panorama direction icons are displayed to show the direction in which pictures will be joined.



- 2 Use the multi selector to choose the direction and press the  button.

Select the direction in which pictures will be joined in the completed panorama; right () , left () , up () or down () .

The yellow panorama direction icon () is displayed for the current direction and the direction is fixed when  is pressed. The icon changes to the white fixed direction  icon.

If necessary, apply flash mode (📖 30), self-timer (📖 32), macro mode (📖 33) and exposure compensation (📖 34) settings with this step. Press the  button again to choose a different direction.



- 3 Frame the first portion of the panorama scene and take the first picture.

One third of the picture will be displayed as translucent.



- 4 Take the next picture.

Frame the next picture so that one third of the frame overlaps the first picture, and press the shutter-release button.

Repeat this process until the necessary number of pictures has been taken to complete the scene.



5 Press the **OK** button when shooting is complete.

The camera returns to step 2.



✓ Notes on Panorama Assist

- Flash mode, self-timer, macro mode and exposure compensation settings cannot be adjusted after the first picture is taken. Pictures cannot be deleted, nor can zoom or **Image mode** setting (📖 99) be adjusted after the first picture has been taken.
- Shooting for the panorama series is terminated if the auto off function (📖 129) initiates standby mode during shooting. Setting the time allowed to elapse before the auto off function is enabled to a longer setting is recommended.

🔍 AE/AF-L Indicator

In **Panorama assist** scene mode, exposure, white balance, and focus for all pictures in a panorama are fixed at the values for the first picture in each series.

When the first picture is taken, **AE/AF-L** is displayed to indicate that exposure, white balance, and focus are locked.



🔍 Panorama Maker





Install Panorama Maker from the supplied Software Suite CD. Transfer pictures to a computer (📖 85) and use Panorama Maker (📖 88) to join them in a single panorama.

🔍 More Information

See "Image/Sound File and Folder Names" (📖 148) for more information.

Shooting in Smart Portrait Mode

At the default settings, the camera uses face priority to recognize human faces, and then automatically releases the shutter when a smile is detected (smile timer). The skin softening option can be used to smooth skin tones of human faces.

- 1 Press the  button in shooting mode to display shooting mode menu, press the multi selector  or  to select , and press the .

The camera enters smart portrait mode.

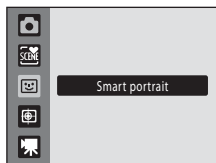

- 2 Frame a picture.

Point the camera at the subject.

When the camera recognizes a human face, a yellow double border (focus area) is displayed around that face. When focus is acquired on that face, the double border will turn green for a moment and focus is locked.

Up to three faces can be recognized. When the camera detects more than one face, the double border is displayed around the face closest to the center of the frame, and single borders around the others.

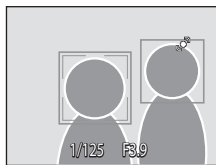

- 3 The shutter is automatically released.

If the camera detects that the face framed by the double border is smiling, **Smile timer** (📖 51) is activated and the shutter is automatically released.

When the camera recognizes a face, the self-timer lamp (📖 4) blinks. Immediately after the shutter is released, the self-timer lamp flickers.

Each time the shutter is released, the camera again initiates face recognition and smile detection operations for continuous automatic shooting.

Pictures can also be taken by pressing the shutter release button. The camera can focus on the subject at the center of the frame when faces are not recognized.

After the shutter is released, processing to soften facial skin tones is performed and the image is saved (**Skin softening** 📖 51).

- 4 Shooting ends.

To exit automatic shooting mode with smile detection, turn the camera off, set **Smile timer** to **Off**, or press the  button to switch to other shooting mode.

Shooting in Smart Portrait Mode

✔ Face Recognition and Smile Face Detection Features

- Under some shooting conditions, the camera may be unable to recognize faces or detect smiles.
- See “Notes on Face Priority” (📖 109) for more information.

✔ Notes on Skin Softening

- More time than usual may be required to save a picture when shooting with skin softening function.
- In some shooting conditions, facial skin tones may not be smoothed or parts other than face may be modified though the camera recognizes a face. If the desired results are not produced, set **Skin softening** to **Off** and shoot again.
- The skin softening level cannot be adjusted when the portrait or night portrait is selected in the scene mode.
- Skin softening can also be applied on recorded picture (📖 77).

✔ Note on Using the Remote Control

When **Smile timer** is set to **On** in smart portrait mode, and the camera recognizes human faces, remote control operation is not available.

✎ Auto Power Off in Smile Timer Mode

When **Smile timer** is set to **On**, the auto power off function (📖 129) is activated and the camera turns off when either of the situations indicated below persists and no other operations are performed.

- The camera does not recognize any faces.
- The camera recognized a face, but cannot detect a smile.

✎ Functions Available in Smart Portrait Mode

- Flash cannot be used when **Blink proof** is set to **On**. When **Blink proof** is set to **Off**, flash mode (📖 30) is set to **♻️** (auto) (can be modified).
- The self timer (📖 32) options can be applied when both **Smile timer** and **Blink proof** are set to **Off**.
- Macro mode (📖 33) cannot be used.
- Exposure compensation (📖 34) is enabled.
- Digital zoom is not available.
- When pressing the **MENU** button to display 📄 (smart portrait) menu, **Image mode**, **Skin softening**, **Smile timer**, or **Blink proof** options can be applied (📖 51).

🔍 More Information

See “Autofocus” (📖 27) for more information.

Smart Portrait Menu

The following options can be applied in the smart portrait menu.

Press the **MENU** button in smart portrait mode to display the smart portrait menu and use the multi selector to apply options.

Image mode

Adjust **Image mode** (📖 99).

Changes made to the image mode setting are reflected in all shooting modes (except movie mode).

Skin softening

Enable skin softening. When the shutter is released, the camera detects one or more human faces (up to three), and processes the image to soften facial skin tones before saving the picture.

The degree of skin softening applied can be selected from **High**, **Normal** (default setting), and **Low**. When **Off** is selected, the skin softening function is disabled.

- The current setting can be confirmed by the indicator displayed in the monitor with shooting (📖 8). No indicator is displayed when **Off** is selected. The effects of skin softening are not visible when framing pictures for shooting. Check the degree of skin softening performed in playback mode.

Smile timer

- **On** (default setting): The camera uses face priority to recognize a human face, and then automatically releases the shutter whenever a smile is detected.
- **Off**: The camera does not release the shutter automatically with smile detection. Press the shutter-release button to take a picture.
- When smile timer is enabled, an indicator is displayed in the monitor with shooting (📖 8). No indicator is displayed when **Off** is selected

Blink proof





When **On** is selected, the camera automatically releases the shutter twice each time a picture is taken. Of the two shots, one in which the subject's eyes are open is saved.

- If the camera saved a picture in which the subject's eyes may have been closed, the dialog shown at right is displayed for a few seconds.
- Flash cannot be used when **On** is selected.
- The default setting is **Off**.
- The current setting is displayed in the monitor (📖 8). No indicator is displayed when **Off** is selected.



Subject Tracking Mode

Use this mode to take pictures of moving subjects. Select the subject which the camera will focus. The focus area will automatically move to track the subject.

- 1** Press the  button in shooting mode to display the shooting mode menu, press the multi selector  or  to select , and press the .

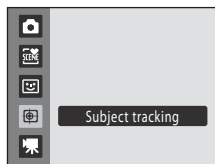

The display switches to that for subject tracking mode and a white single border is displayed at the center of the frame.

- 2** Select a subject.

Align the subject with the single border at the center of the frame and press the .

- The subject is selected.
- When the camera is unable to focus on the subject, the single border will glow red. Change the composition and try again.



When the subject is selected, a yellow focus area indicator will be displayed around that subject and the camera will start tracking that subject.

To change the subject, press the  button to deselect the current subject.

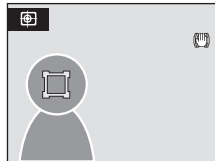

If the selected subject is not visible in the monitor, the focus area indicator will disappear and the selection will be cancelled. Select the subject again.

- 3** Press the shutter-release button to take a picture.

The camera focuses on the focus area when the shutter-release button is pressed halfway. The focus area indicator will glow green and focus will be locked.

When the camera is unable to focus, the focus area indicator will blink. Press the shutter-release button halfway again to focus.

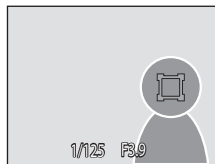

If the shutter-release button is pressed halfway while the focus area indicator is not displayed, the camera focuses on the subject at the center of the frame.

Press the shutter-release button all the way down to release the shutter.

✓ Notes on Subject Tracking Mode

- Adjust zoom position, exposure, menu settings, and flash mode prior to selecting the subject. If any camera setting is changed after the subject has been selected, subject selection will be cancelled.
- It may be impossible to select the desired subject, or the camera may be unable to track the selected subject or may begin tracking a different subject, if the subject is moving rapidly, if there is a significant amount of camera shake, or if the camera recognizes a similar subject. The camera's ability to accurately track the selected subject is also dependent upon the size and brightness of the subject.
- In some rare cases shooting subjects with which autofocus may not perform as expected (📖 27), the subject may not be in focus despite the fact that the focus area indicator glows green. Should this occur, switch to auto mode and set **AF area mode** (📖 106) to **Manual** or **Center**, refocus on another subject positioned at the same distance from the camera as the actual portrait subject, and use focus lock (📖 107).

📌 Functions Available in Subject Tracking Mode

- Digital zoom is not available.
- Flash mode (📖 30) and exposure compensation (📖 34) settings can be adjusted.
- Self-timer (📖 32) and macro mode (📖 33) cannot be used.
- The **Image mode** (📖 99) setting can be adjusted by pressing the **MENU** button to display the  (subject tracking) menu.
 - Changes made to the image mode setting apply to all shooting modes (except those available from the movie mode).

📌 Autofocus

After a subject is selected and subject tracking begins, the camera focuses continuously until focus is locked by pressing the shutter-release button halfway. Therefore, the sound of lens drive movement can be heard.

Viewing Multiple Pictures: Thumbnail Playback

Rotate the zoom control to **W** (📐) in full-frame playback mode (📖 28) to display pictures in “contact sheets” of thumbnail images.

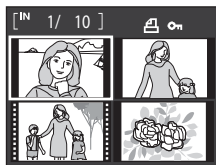

The following operations are available while thumbnails are displayed.

To	Use	Description	📖
Choose pictures		Press the multi selector ▲, ▼, ◀, or ▶.	11
Increase the number of pictures displayed/apply the calendar display	W (📐)	Rotate the zoom control to W (📐) to increase the number of picture thumbnails displayed: 4 → 9 → 16. Rotate the zoom control to W (📐) in the 16-picture thumbnail display to apply the calendar display (📖 56), and pictures can be found by the date on which they were taken. Rotate the zoom control to T (📷) to return to thumbnail display.	–
Decrease the number of pictures displayed	T (📷)	Rotate the zoom control to T (📷) to decrease the number of picture thumbnails displayed: 16 → 9 → 4. Rotate the zoom control to T (📷) in 4-picture thumbnail display to return to full-frame playback mode.	–
Cancel thumbnail playback		Press the button.	28
Switch to shooting mode		Press the button or the shutter-release button to return to the last shooting mode selected.	28

Thumbnail Playback Mode Display

When pictures marked for printing (📖 95) or protected pictures (📖 114) are selected, the icons shown at right are displayed with them. Movies are displayed as film frames.

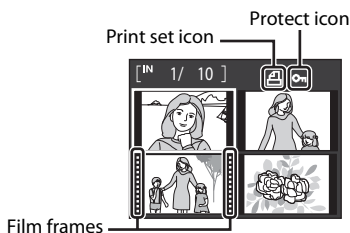

Thumbnail Display in Auto Sort and Favorite Pictures Mode

- When thumbnails are displayed in auto sort mode (📖 61), the category icon of the pictures is displayed at right above the thumbnails.
- When thumbnails are displayed in favorite pictures mode (📖 64), the favorite pictures icon is displayed at right above the thumbnails.

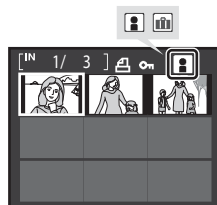

Calendar Display

Rotate the zoom control to **W** (📷) with 16 thumbnails displayed (📖 54) to switch to calendar display.

Selecting a date displays the first picture taken on that date in full-frame playback mode. The dates on which the pictures were taken are underlined in yellow.

The following operations are available in calendar display.

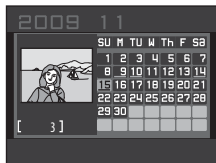

To	Use	Description	📖
Select date		Press the multi selector ▲, ▼, ◀, or ▶.	11
Return to full-frame playback		The first picture taken on the selected date is displayed full frame.	28
Return to thumbnail display	T (📷)	Rotate the zoom control to T (📷).	54

✔ Notes on Calendar Display

- Pictures taken before the date and time have been set are recognized as having been taken on 01/2009.
- The button and **MENU** button are not available in calendar display.

📷 List by Date Mode

Only the pictures taken on the same date can be played back in list by date mode (📖 58). The playback menu operations (📖 60) are also available only for the pictures taken on the selected dates.

Taking a Closer Look: Playback Zoom

Rotating the zoom control to **T** (Q) in full-frame playback mode (📖 28) enlarges display of the center portion of the current picture.

- The guide displayed at bottom right shows the portion of the image currently displayed.

The following operations can be performed while picture display is enlarged.

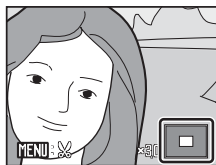

To	Use	Description	📖
Zoom in	T (Q)	Zoom increases each time the zoom control is rotated to T (Q), to a maximum of 10x.	–
Zoom out	W (R)	Zoom decreases each time the zoom control is rotated to W (R). When the magnification ratio reaches 1x, the display returns to full-frame playback mode.	–
View other areas of picture		Press the multi selector ▲, ▼, ◀, or ▶ to move the display area to other areas of the picture.	11
Switch to full-frame playback	OK	Press the OK button.	28
Crop picture	MENU	Press the MENU button to crop current picture to contain only the portion visible in the monitor.	80
Switch to shooting mode		Press the button or the shutter-release button to return to the current shooting mode.	28

Pictures Taken with Face Priority

When zooming in (playback zoom) on a picture taken using the face-priority function (📖 108) by rotating the zoom control to **T** (Q), the picture will be enlarged with the face recognized with shooting at the center of the monitor (except pictures taken with **Continuous**, **BSS** and **Multi-shot 16**; 📖 103).





- If more than one face was recognized, the picture will be enlarged with the face on which focus was acquired at the center of the monitor. Press the multi selector ▲, ▼, ◀, or ▶ to display other recognized faces.
- When the zoom control is rotated to **T** (Q) or **W** (R) to adjust the zoom ratio, the center of the picture (normal playback zoom display), rather than the face, is displayed at the center of the monitor.



Viewing Pictures by Date (List by Date Mode)

In “**DATE** list by date mode”, pictures taken on the same date can be played back. In full-frame playback mode, just as with normal playback mode, picture display can be enlarged, pictures can be edited or added to albums, and movies can be played back. When the **MENU** button is pressed, the list by date menu (📅 60) is displayed, and all pictures taken on a specified date can be selected for deletion, viewing in a slide show, printing, and protection.

Selecting a Date in List by Date Mode

- 1 Press the  button in playback mode to display the playback-mode selection menu and press the multi selector  or  to choose **DATE**, and then press the  button.



Dates for which pictures exist are listed.





- 2 Select the desired date.

Camera lists up to 29 dates. If pictures exist for more than 29 dates, all pictures recorded earlier than most recent 29 dates will be combined under **Others**.



Press the  button to display the first picture taken on the selected date.

Select an image and press the  button to sort the image to the album (📖 66).

Rotate the zoom control to **W** () in full-frame playback mode to return to the list by date screen.

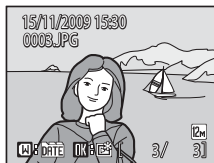













✓ Notes on List by Date Mode

- Up to 9,000 of the most recently recorded pictures can be displayed in list by date mode. If more pictures are exist, “*” is displayed next to the number of pictures for folder(s) containing pictures older than the most recent 9,000.
- Pictures taken before the date and time have been set are recognized as having been taken on 01/01/2009.











Using List by Date Mode

The following operations are available in the list by date screen.

To	Use	Description	
Select date		Press the multi selector ▲ or ▼ to select a date.	11
Switch to full-frame playback		Press the OK button to display the first picture taken on the selected date. Rotate the zoom control to W () in full-frame playback mode to return to the list by date screen.	28
Delete picture		Press the  button to delete after selecting a date, and a confirmation dialog will be displayed. Choose Yes and press the OK button to delete all pictures taken on the date.	28
View list by date menu	MENU	Press the MENU button to display the list by date menu.	60
Switch to another playback mode		Press the  button to display the playback-mode selection menu.	10
Switch to shooting mode		Press the  button or the shutter-release button to return to the last shooting mode selected.	28
	 		
Switch to projector mode		Use the built-in projector to project pictures taken on the selected date.	139

List by Date Menu

Press the **MENU** button in list by date mode to display the following menus for only the pictures taken on the specified date.

Quick retouch*	→  75
D-Lighting*	→  76
Skin softening*	→  77
Print set	→  95
Slide show	→  113
Delete	→  114
Protect	→  114
Rotate image*	→  115
Small picture*	→  79
Voice memo*	→  71

* During full-frame playback only













When the **MENU** button is pressed in the list by date screen ( 58), options can be applied to all pictures taken on the same date, or all pictures taken on the same date can be deleted. To apply options to individual pictures, or to select individual pictures for deletion, display a picture full-frame and press the **MENU** button.





Image Searching in Auto Sort Mode

Pictures and movies are automatically sorted to any of the following categories with shooting. When “ auto sort mode” is selected, pictures and movies can be viewed by selecting the category to which they were sorted.

 Smile	 Portraits	 Food
 Landscape	 Dusk to dawn	 Close-ups
 Movie	 Retouched copies	 Other scenes

In full-frame playback mode, just as with normal playback mode, picture display can be enlarged and pictures can be displayed as thumbnails or in calendar mode. Still pictures can be edited and added to albums, and movies can be played back. When the **MENU** button is pressed, the auto sort menu ( 63) is displayed, and all pictures sorted to the specified category can be selected for deletion, viewing in a slide show, printing, or protection.

Displaying Pictures in Auto Sort Mode

- 1 Press the  button in playback mode to display the playback-mode selection menu and press the multi-selector  or  to choose , and then press the .

A list of categories is displayed.

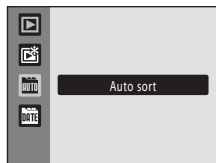

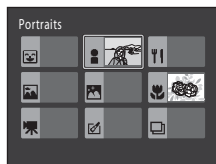

- 2 Select a desired category.

For details of categories, see “Categories and the Contents” ( 62).









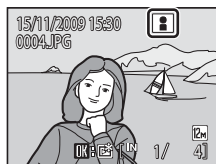



Press the  button to display a picture in the selected category in full-frame playback mode.

The icon of the category currently played back will be displayed at the top right of the screen.

Select an image and press the  button to sort the image to the album ( 66).



Categories and the Contents

Folder name	Description
 Smile	Pictures taken in smart portrait mode (📖 49) with the smile timer setting set to On are displayed.
 Portraits	Pictures taken in  (auto) mode (📖 22) with the face priority and those taken in Portrait* , Night portrait* , Party/indoor , and Backlight* scene mode (📖 36) are displayed. Pictures taken in smart portrait mode (📖 49) with the smile timer setting set to Off are displayed.
 Landscape	Pictures taken in Landscape* scene mode (📖 36) are displayed.
 Dusk to dawn	Pictures taken in Night landscape* , Sunset , Dusk/dawn and Fireworks show scene mode (📖 36) are displayed.
 Close-ups	Pictures taken in Close-up* scene mode (📖 36) and those taken in  (auto) mode with macro mode (📖 33) are displayed.
 Food	Pictures taken in Food scene mode (📖 36) are displayed.
 Movie	Movies (📖 81) are displayed.
 Retouched copies	Copies created using editing function (📖 73) are displayed.
 Other scenes	All other pictures that cannot be defined by the categories described above are displayed.











* The pictures taken in scene auto selector mode (📖 43) are also sorted to the appropriate categories.

Notes on Auto Sort Mode

- Up to 999 pictures and movie files can be sorted to each category in auto sort mode. If 999 pictures or movies have already been sorted to a specific category, new pictures and movies cannot be sorted to that category or displayed in auto sort mode. Display pictures and movies that could not be sorted to a category in normal playback mode (📖 28) or list by date mode (📖 58).
- Pictures or movies copied from the internal memory or the memory card (📖 115) cannot be displayed in auto sort mode.
- Pictures or movies recorded by a camera other than the COOLPIX S1000pj cannot be displayed in auto sort mode.











Using Auto Sort Mode

The following operations are available in the category list screen.

To	Use	Description	
Select the folder name		Press the multi selector ▲, ▼, ◀, or ▶ to select the folder.	11
Switch to full-frame playback		Press the OK button to display the first picture in the selected folder.	28
Delete picture		Press the  button after selecting a category, and a confirmation dialogue will be displayed. Choose Yes and press the OK button to delete all pictures sorted to that category.	28
Switch to another playback mode		Press the  button to display the playback-mode selection menu.	10
Switch to shooting mode		Press the  button or the shutter-release button to return to the last shooting mode selected.	28
			
Switch to projector mode		Use the built-in projector to project pictures sorted to the selected category.	139

Auto Sort Menu

Press the **MENU** button in full-frame playback mode or thumbnail playback mode in auto sort mode to apply the following menu options.

Quick retouch	→  75
D-Lighting	→  76
Skin softening	→  77
Print set	→  95
Slide show	→  113
Delete	→  114
Protect	→  114
Rotate image	→  115
Small picture	→  79
Voice memo	→  71

Sorting Favorite Pictures (Favorite Pictures Mode)

Pictures can be added to albums for specific events, such as vacations or weddings, or themes. When viewing albums, only the pictures sorted to the current album are displayed. Individual pictures can be added to multiple albums.



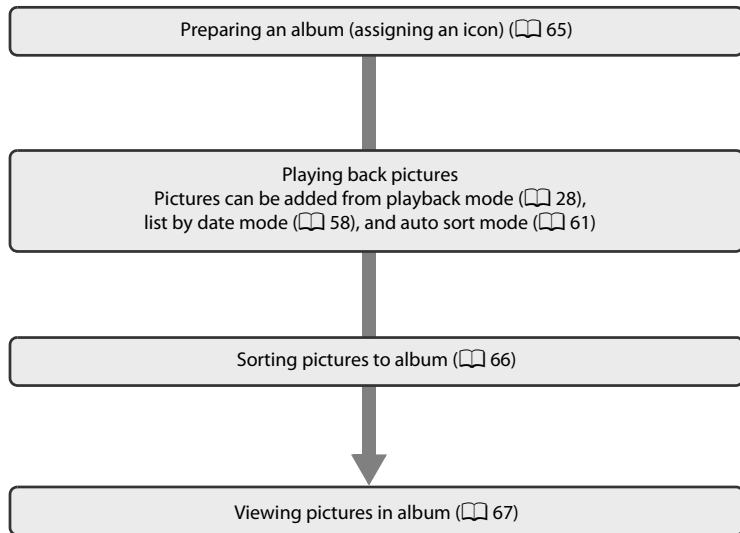

Sorting/Playback Procedure



Preparing an Album (Assigning an Icon)

The icon assigned to an album can be changed to reflect the theme of pictures included in the album.

- Album icons can be assigned or changed even after pictures have been added to albums.

- 1 Press the  button in playback mode to display the playback-mode selection menu and press the multi selector  or  to choose , and then press the  button.

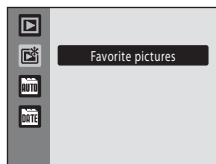

A list of albums is displayed.





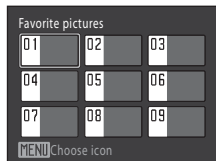
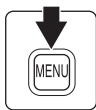

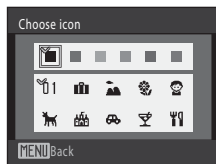

- 2 Choose the album and press the **MENU** button.

The icon selection screen is displayed.



- 3 Use the multi selector  or  to choose an icon color and press the  button.



- 4 Use the multi selector , , , or  to choose an icon and press the  button.

The icon is modified and monitor display returns to the list of albums.

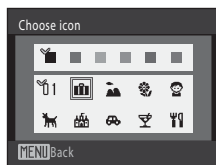

Notes on Icons for Albums

Choose icons for albums separately for the internal memory and for every memory card used.

- To change the icon for an album containing pictures stored in the internal memory, remove the memory card from the camera.
- A number (default setting) is displayed in place of an icon for albums for which an icon has not been specified, whether the albums contain pictures stored in the internal memory or on a memory card.

Adding Pictures to Albums

Pictures can be sorted by adding them to albums. Adding pictures to albums makes it faster and easier to find specific pictures.

1 Display pictures in playback mode (📖 28), list by date mode (📖 58), or auto sort mode (📖 61).

2 Select a favorite picture and press the **OK** button.

Select full-frame playback mode and press the **OK** button.
The albums selection screen is displayed.

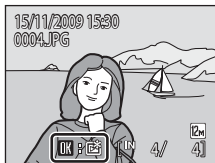

3 Use the multi selector to choose a desired album and press the **OK** button.

The picture is added to the selected album.

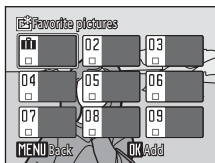



✓ Notes on Adding Favorite Pictures





- An album can contain up to 200 pictures.
- If the selected picture has already been added to an album, the checkbox for the folder to which it has been added will be checked (✓).
- One picture can be added to multiple albums.
- When pictures are added to albums, they are not physically copied to albums or moved from the folder (📖 148) to which they were originally recorded (📖 70).
- Movies cannot be added to albums.

🔍 More information

See "Removing Pictures from Albums" (📖 68) for more information.

Viewing Pictures in an Album

Pictures can be displayed by selecting the album to which they were added in “ favorite pictures mode”. In full-frame playback mode, just as with normal playback mode, picture display can be enlarged and pictures can be displayed as thumbnails or in calendar mode. Still pictures can be edited and movies can be played back. When the **MENU** button is pressed in the full-frame or thumbnail playback mode to display the favorite pictures menu ( 69), all pictures sorted to the specified album can be selected for deletion, viewing in a slide show, printing, or protection.

- 1 Press the  button in playback mode to display the playback-mode selection menu, press the multi-selector  or  to choose , and press the  button.

A list of albums is displayed.



- 2 Choose the desired album.

Press the  button to display a picture in the selected album in full-frame playback mode.

The icon for the current album is displayed at the top right of the screen.

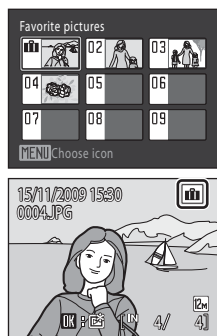

Removing Pictures from Albums

To remove a picture from an album without permanently deleting it, follow the procedures described below.

- Select the desired picture in full-frame display in step 2 in favorite pictures mode (☞ 67), and press the **OK** button to display the confirmation dialog.
- To remove the picture from the album, choose **Yes** and press the **OK** button. To continue without removing the picture, choose **No** and press the **OK** button.

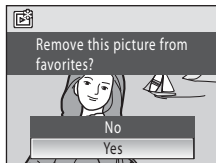















✓ Note on Deleting Pictures in Favorite Pictures Mode

Note that deleting a picture in favorite pictures mode deletes not only the picture from the album, but also deletes the original picture from the internal memory or memory card permanently (☞ 70).







Using Favorite Pictures Mode

The following operations are available with display of album list.

To	Use	Description	
Select album		Press the multi selector ▲, ▼, ◀, or ▶.	11
Switch to full-frame playback		Press the  button to display the first picture in the album.	28
Delete picture		Press the  button after selecting an album, and a confirmation dialog will be displayed. Choose Yes and press the  button to delete all pictures sorted to that album.	28
Change album icon	MENU	Change the icon assigned to an album.	65
Switch to another playback mode		Press the  button to display the playback-mode selection menu.	10
Switch to shooting mode	  	Press the  button or the shutter-release button to return to the last shooting mode selected.	28
Switch to projector mode		Use the built-in projector to project pictures added to the selected album.	139

Favorite Pictures Menu

Press the **MENU** button in full-frame playback mode or thumbnail playback mode in favorite pictures mode to apply the following menu options.

Quick retouch	→  75
D-Lighting	→  76
Skin softening	→  77
Print set	→  95
Slide show	→  113
Delete	→  114
Protect	→  114
Rotate image	→  115
Small picture	→  79
Voice memo	→  71

Sorting Favorite Pictures (Favorite Pictures Mode)

Adding/Viewing Favorite Pictures

When pictures are added to albums, they are not physically copied to albums or moved from the album to which they were originally recorded (📖 148). Only the file names of pictures are added to albums. In favorite pictures mode, pictures with file names that have been added to the specified album are played back. Note that deleting a picture (📖 28, 69, 114) played back in favorite pictures mode deletes not only the picture from the album, but also deletes the original picture from the internal memory or memory card permanently.

Adding Pictures to Albums

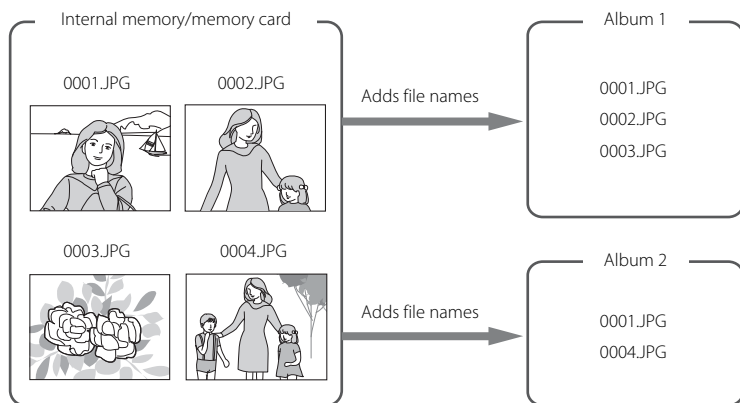

Favorite Pictures Playback

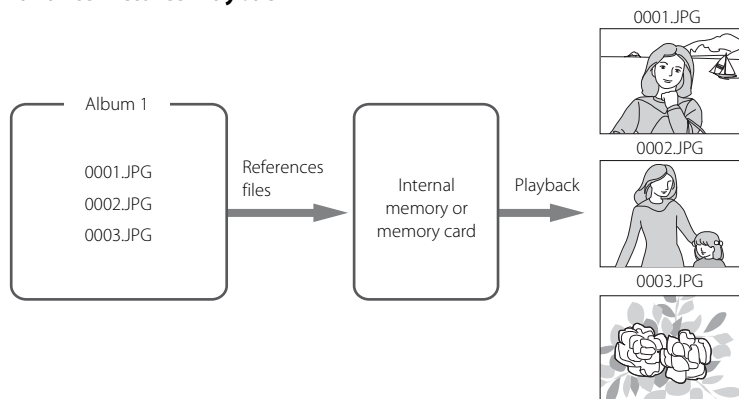

Voice Memos: Recording and Playback

Use the camera's built-in microphone to record voice memos for pictures.

Recording Voice Memos

- 1 Display the desired picture in full-frame playback mode (📖 28) or thumbnail playback mode (📖 54) and press the **MENU** button.

The playback menu is displayed.



- 2 Use the multi selector to choose **Voice memo** and press the **OK** button.

The screen for recording voice memos is displayed.

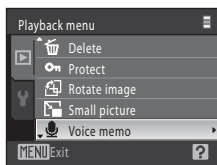

- 3 Press and hold the **OK** button to record a voice memo.

Recording ends after about 20 seconds or when the **OK** button is released.

Do not touch the built-in microphone during recording. During recording, **REC** and **[M]** blink in the monitor.

When recording ends, the voice memo playback screen is displayed. Follow the instructions in step 3 of "Playing Voice Memos" (📖 72) to play the voice memo.

Press the **MENU** button before or after recording a voice memo to return to full-frame playback mode.

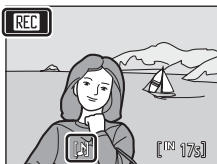



More Information

See "Image/Sound File and Folder Names" (📖 148) for more information.

Playing Voice Memos

Pictures for which voice memos have been recorded are indicated by  in full-frame playback mode.

- 1 Select the desired picture in full-frame playback mode ( 28) or thumbnail playback mode ( 54) and press the **MENU** button.

The playback menu is displayed.

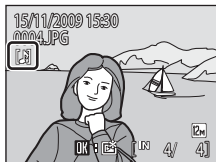

- 2 Use the multi selector to choose  **Voice memo** and press the **OK** button.

The voice memo playback screen is displayed.

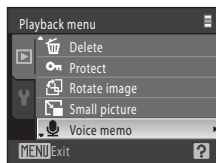

- 3 Press the **OK** button to play the voice memo.



Playback ends when the voice memo ends or the **OK** button is pressed again.

Rotate the zoom control to **T** or **W** during playback to adjust playback volume.

Press the **MENU** button before or after playing a voice memo to return to full-frame playback mode.



Deleting Voice Memos

Select a picture with a voice memo and press the  button. Use the multi selector to choose  and press the **OK** button. Only the voice memo will be deleted.



Voice Memos

- When a picture with a voice memo attached is deleted, both the picture and its voice memo are deleted.
- If a voice memo already exists for the current picture, it must be deleted before a new voice memo can be recorded.
- The COOLPIX S1000pj is not able to attach a voice memo to pictures recorded by other cameras.

Editing Pictures

Use the COOLPIX S1000pj to edit pictures in-camera and store them as separate files (📖 148). The editing functions described below are available.

Editing function	Description
Quick retouch (📖 75)	Easily create retouched copies in which contrast and saturation have been enhanced.
D-Lighting (📖 76)	Create a copy of the current picture with enhanced brightness and contrast, brightening dark portions of the picture.
Skin softening (📖 77)	The camera detects faces and creates a copy of the picture with softer skin tones in the faces of portrait subjects.
Small picture (📖 79)	Create a small copy of pictures suitable for use as e-mail attachments.
Crop (📖 80)	Enlarge the image or refine the composition and create a copy containing only the portion visible in the monitor.

✔ Notes on Picture Editing

- Pictures taken at an **Image mode** setting of **16:9 (3968)** (📖 99) cannot be edited.
- The COOLPIX S1000pj editing functions are not available for pictures taken with another model of digital cameras.
- If no face is recognized in a picture, a copy cannot be created using the skin softening option (📖 77).
- Edited copies created with this camera may not be displayed properly on a different model of digital camera. It may also be impossible to transfer them to a computer using a different model of digital camera.
- Editing functions are not available when there is not enough free space in the internal memory or on the memory card to store the edited copies.

📎 Restrictions on Picture Editing

When an edited copy is further modified with another editing function, check the following restrictions.

Editing function used	Editing function to add
Quick retouch D-Lighting	The skin softening, small picture and crop functions can be added. The quick retouch and D-Lighting function cannot be used in conjunction on a picture.
Skin softening	The quick retouch, D-Lighting, small picture, and crop function can be added.
Small picture Crop	Another editing function cannot be added.

- Copies created with editing functions cannot be further edited with the same function used to create them.
- Small picture copies and cropped copies cannot be further modified using other editing functions. Use the copy and crop functions after other editing functions have been applied.
- The skin softening function can be added to the picture taken with skin softening (📖 51).

Original and Edited Pictures

- Copies created with editing functions are not deleted if the original pictures are deleted. The original pictures are not deleted if copies created with editing functions are deleted.
- Edited copies are stored with the same recording date and time as the original.
- **Print set** (📖 95) and **Protect** (📖 114) settings configured for original pictures are not reflected in their edited copies.

Enhancing Contrast and Saturation: Quick Retouch

Quick retouch can be used to easily create retouched copies in which contrast and saturation have been enhanced. New copies are stored as separate files.

- 1 Select the desired picture from full-frame (📖 28) or thumbnail (📖 54) playback mode and press the **MENU** button.

The playback menu is displayed.



- 2 Use the multi selector to choose  **Quick retouch** and press the **OK** button.

The original version is displayed on the left and the edited version is displayed on the right.

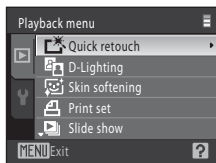

- 3 Press the multi selector **▲** or **▼** to choose the degree of enhancement performed and press the **OK** button.

A new copy is created.

To exit without saving the copy, press the **MENU** button.

Copies created with the quick retouch option can be recognized by the  icon displayed during playback.

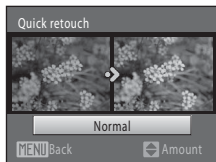

More Information

See "Image/Sound File and Folder Names" (📖 148) for more information.

Enhancing Brightness and Contrast: D-Lighting

D-Lighting can be used to create copies with enhanced brightness and contrast, brightening dark portions of a picture. New copies are stored as separate files.

- 1 Select the desired picture from full-frame (📖 28) or thumbnail (📖 54) playback mode and press the **MENU** button.

The playback menu is displayed.

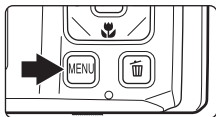

- 2 Use the multi selector to choose **D-Lighting** and press the **OK** button.

The original version is displayed on the left and the edited version is displayed on the right.

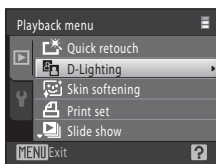

- 3 Choose **OK** and press the **OK** button.

A new copy with enhanced brightness and contrast is created.

To exit without saving the copy, choose **Cancel** and press the **OK** button.

D-Lighting copies can be recognized by the **DL** icon displayed during playback.

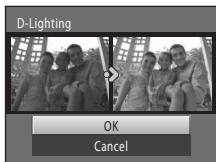

More Information

See "Image/Sound File and Folder Names" (📖 148) for more information.

Softening Skin Tones: Skin Softening

The camera detects faces in pictures and creates a copy with softer facial skin tones. Copies created with the skin softening function are stored as separate files.

- 1 Select the desired picture in full-frame (📖 28) or thumbnail (📖 54) playback mode and press the **MENU** button.

The playback menu is displayed.

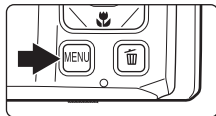

- 2 Use the multi selector to choose  **Skin softening** and press the **OK** button.

The display for selecting the degree of enhancement to be performed is shown.

If no faces are recognized in the picture, an alert is displayed and the camera returns to playback mode.

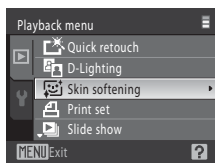

- 3 Press the multi selector **▲** or **▼** to choose the degree of enhancement performed and press the **OK** button.

The confirmation screen is displayed with the face to which skin softening was applied enlarged at the center of the monitor.

To exit without saving the copy, press the **MENU** button.

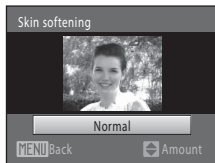

- 4 Check the enhancement performance.

Up to 12 faces can be enhanced in the order of nearest from the center of the frame.

If more than one softened face is displayed, press the multi selector **◀** or **▶** to display other faces.

To change the degree of effect, press the **MENU** to return to step 3.

Press the **OK** button to display a new, created copy.

Copies created with the skin softening function can be recognized by the  indicator displayed during playback.

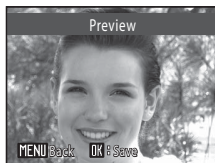

Note on Skin Softening



Depending upon the direction the face is looking or the brightness of the subject, faces may not be correctly detected, or the skin softening function may not perform as expected.

More Information

See "Image/Sound File and Folder Names" ( 148) for more information.

Resizing Pictures: Small Picture

Create a small copy of the current picture. Small copies are stored as JPEG files with a compression ratio of 1:16. The following sizes are available.

Option	Description
 640×480	Suited to television playback.
 320×240	Suited to display on Web pages.
 160×120	Suited to use as e-mail attachments.

- 1 Select the desired picture from full-frame (📖 28) or thumbnail (📖 54) playback mode and press the **MENU** button.

The playback menu is displayed.



- 2 Use the multi selector to choose  **Small picture** and press the **OK** button.

To exit without saving the copy, press the **MENU** button.

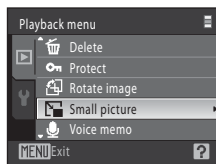

- 3 Choose the desired copy size and press the **OK** button.

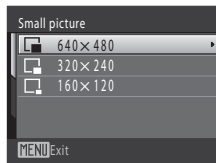

- 4 Choose **Yes** and press the **OK** button.

A new, smaller copy is created.

To exit without saving the copy, choose **No** and press the **OK** button.

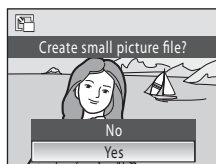

The copy is displayed with a gray frame.



More Information

See "Image/Sound File and Folder Names" (📖 148) for more information.

Creating a Cropped Copy: Crop

Create a copy containing only the portion visible in the monitor when **MENU**  is displayed with playback zoom ( 57) enabled. Cropped copies are stored as separate files.

1 Rotate the zoom control to **T** in full-frame playback mode to zoom in on the image.

To crop a picture displayed in “tall” (portrait) orientation, zoom in on the picture until the black bars displayed on the both sides of the monitor disappear. The cropped picture will be displayed in landscape orientation.

To crop the picture in its current “tall” (portrait) orientation, first use the **Rotate image** option ( 115) to rotate the picture so that it is displayed in landscape orientation. Next, enlarge the picture for cropping, crop the picture, and then rotate the cropped picture back to “tall” (portrait) orientation.

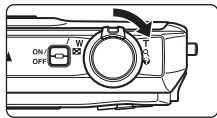

2 Refine crop composition.

Rotate the zoom control to **T**  or **W**  to adjust the zoom ratio.

Press the multi selector , ,  or  to scroll the picture until only the portion you want to copy is visible in the monitor.



3 Press the **MENU** button.

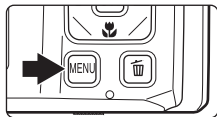

4 Use the multi selector to choose **Yes** and press the button.

A new picture, containing only the portion visible in the monitor, is created.



To exit without saving the copy, choose **No** and press the  button.



Image Size





As the area to be saved is reduced, the image size (pixels) of the cropped copy is also reduced. When the size of the cropped copy is 320 × 240 or 160 × 120, a gray frame is displayed around the picture during playback, and the small picture icon  or  is displayed at the left of the monitor in full-frame playback mode.

More Information

See “Image/Sound File and Folder Names” ( 148) for more information.

Recording Movies

To shoot movies with sound recorded via the built-in microphone, enter shooting mode and follow the steps below.

- 1 Press the  button in shooting mode to display the shooting mode menu and press the multi selector  or  to select , and then press the .



The maximum movie length that can be recorded is displayed in the monitor ( 82).

The maximum recording time for a single movie is 25 minutes, or a file size of 2 GB, even when there is enough free space in the internal memory or on the memory card.

- 2 Press the shutter-release button all the way down to start recording.

The camera focuses on the subject at the center of the frame.





A progress bar at the bottom of the monitor shows the amount of recording time remaining.



To end recording, press the shutter-release button all the way down a second time.

Recording stops automatically when the movie length indicator reaches "0".

Recording Movies

- The flash ( 30), self-timer ( 32) and exposure compensation ( 34) cannot be used, nor can their settings be adjusted in movie mode. Macro mode ( 33) is available.
- Macro mode cannot be enabled or disabled while movies are being recorded. Enable or disable macro mode before movie recording begins.
- Optical zoom cannot be adjusted once movie recording begins. Digital zoom cannot be applied before movie recording begins. However, digital zoom (up to 2x) can be applied while movies are being recorded.

Note on Recording Movies

When the movie has been fully recorded to the internal memory or memory card, the monitor display will revert to the normal shooting mode display. **Do not open the battery-chamber/memory card slot cover** while movies are being recorded. Removing the memory card while movies are being recorded could result in loss of data or in damage to the camera or card.

Autofocus

Camera focuses when shutter-release button is pressed halfway and locks at this position during shooting. The focus is set to this position during shooting.

Adjusting Movie Settings





Movie options ( 82) settings can be adjusted from the movie menu.

The Movie Menu





Movie options settings can be adjusted from the movie menu. Press the **MENU** button in movie mode to display the movie menu and use the multi selector to modify and apply settings.

Movie Options

The movie menu offers the options shown below.

Option	Image size and frame rate
 TV movie 640★ (default setting)	Image size: 640 × 480 pixels Frame rate: 30 frames per second
 TV movie 640	Image size: 640 × 480 pixels Frame rate: 15 frames per second
 Small size 320★	Image size: 320 × 240 pixels Frame rate: 30 frames per second
 Small size 320	Image size: 320 × 240 pixels Frame rate: 15 frames per second

Movie Options and Maximum Movie Length

Option	Internal memory (approx. 36 MB)	Memory card (512 MB)
 TV movie 640★ (default setting)	32 s	7 min 20 s
 TV movie 640	1 min 2 s	14 min 10 s
 Small size 320★	1 min 2 s	14 min 10 s
 Small size 320	1 min 59 s	25 min

* All figures are approximate. The maximum recording time may vary with make of memory card. The maximum recording time for a single movie is 25 minutes, or a file size of 2 GB, even when there is enough free space in the internal memory or on the memory card. The maximum movie length that can be recorded for a single movie is displayed during recording.

More Information

See "Image/Sound File and Folder Names" (📖 148) for more information.

Movie Playback

In full-frame playback mode (📖 28), movies are recognized by the **Movie options** icon (📖 82). To play a movie, display it in full-frame playback mode and press the **OK** button.

Rotate the zoom control to **T** or **W** to adjust playback volume.

Playback controls are displayed at the top of the monitor. Press the multi selector ◀ or ▶ to choose a control, then press the **OK** button to perform the selected operation. The operations described below are available.

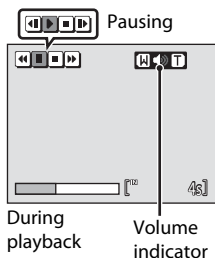

To	Use	Description						
Rewind	⏮	Hold down the OK button to rewind movie.						
Fast-forward	⏭	Hold down the OK button to fast-forward movie.						
Pause	⏸	Press the OK button to pause playback. The following operations can be performed while playback is paused using the controls displayed at top in the monitor.						
		<table border="1"> <tr> <td>⏮</td> <td>Press the OK button to rewind movie one frame. Hold down the OK button for continuous frame-by-frame rewind.</td> </tr> <tr> <td>⏭</td> <td>Press the OK button to advance movie one frame. Hold down the OK button for continuous frame-by-frame advance.</td> </tr> <tr> <td>▶</td> <td>Press the OK button to resume playback.</td> </tr> </table>	⏮	Press the OK button to rewind movie one frame. Hold down the OK button for continuous frame-by-frame rewind.	⏭	Press the OK button to advance movie one frame. Hold down the OK button for continuous frame-by-frame advance.	▶	Press the OK button to resume playback.
		⏮	Press the OK button to rewind movie one frame. Hold down the OK button for continuous frame-by-frame rewind.					
⏭	Press the OK button to advance movie one frame. Hold down the OK button for continuous frame-by-frame advance.							
▶	Press the OK button to resume playback.							
End	⏹	Press the OK button to return to full-frame playback mode.						

Deleting Movie Files

Select a movie and press the **Trash** button in full-frame playback mode (📖 28) or thumbnail playback mode (📖 54). A confirmation dialog is displayed. Choose **Yes** and press the **OK** button to delete the movie, or choose **No** and press the **OK** button to return to the normal playback display without deleting the movie.

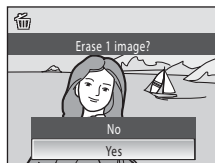

Connecting to a TV

Connect the camera to a television using the supplied audio/video cable to play back pictures on a television.

1 Turn off the camera.

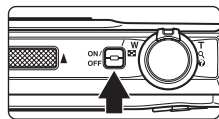

2 Connect the camera to the TV using the supplied A/V cable.

Connect the yellow plug to the video-in jack and the white plug to the audio-in jack on the TV.

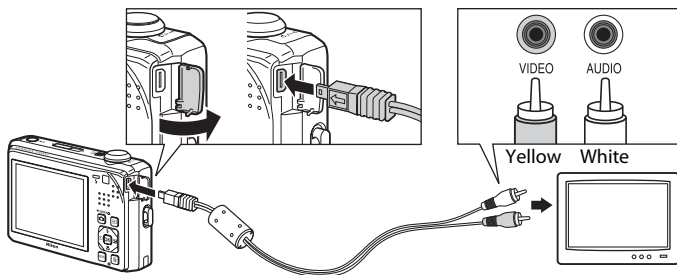

3 Tune the television to the video channel.

See the documentation provided with your television for details.

4 Hold down the button to turn on the camera.

The camera enters playback mode and pictures are displayed on the television.

While connected to the TV, the camera monitor will remain off.



Connecting an A/V Cable

When connecting the A/V cable, be sure that the camera connector is properly oriented. Do not use force when connecting the A/V cable to the camera. When disconnecting the A/V cable, do not pull the connector at an angle.

Video Mode

Be sure that the camera's video mode setting conforms to the standard used by your television. The video mode setting is specified from the **Video mode** (📖 131) option in the **Set up** menu (📖 117).

Connecting to a Computer

Use the supplied USB cable to connect the camera to a computer, and copy (transfer) pictures to a computer with the supplied Nikon Transfer software.

Before Connecting the Camera

Install the Software

Before connecting the camera to a computer, software, including Nikon Transfer, ViewNX for viewing transferred pictures, and Panorama Maker for creating panorama images, must be installed from the supplied Software Suite CD.

For more information on installing the software, refer to the *Quick Start Guide*.

Compatible Operating Systems

Windows

Preinstalled versions of Windows Vista Service Pack 1 (32-bit Home Basic/Home Premium/Business/Enterprise/Ultimate editions),

Windows XP Service Pack 3 (Home Edition/Professional)

Macintosh

Mac OS X (version 10.3.9, 10.4.11, 10.5.6)

Refer to the Nikon website for the latest information on operating system compatibility.

Notes on Power Source

- When connecting the camera to a computer, use a fully charged battery to prevent the camera from turning off unexpectedly.
- If the AC Adapter EH-62F (available separately) is used, COOLPIX S1000pj can be powered from a home electrical outlet. Do not use any other make or model of AC adapter as they may cause the camera to overheat or malfunction.

Transferring Pictures from the Camera to a Computer

- 1 Start the computer to which Nikon Transfer was installed.
- 2 Be sure that the camera is off.
- 3 Connect the camera to the computer using the supplied USB cable.

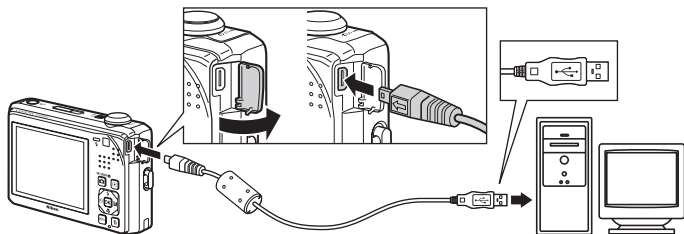

- 4 Turn on the camera.

The power-on lamp will light. The camera monitor will remain off.

Windows Vista

When the AutoPlay dialog is displayed, click **Copy pictures to a folder on my computer using Nikon Transfer**. Nikon Transfer will start.

To bypass this dialog in the future, check **Always do this for this device**.

Windows XP

When the action selection dialog is displayed, select **Nikon Transfer Copy pictures to a folder on my computer** and click **OK**. Nikon Transfer will start.

To bypass this dialog in the future, check **Always use this program for this action**.

Mac OS X

Nikon Transfer will start automatically if **Yes** was selected in the Auto-Launch setting dialog when Nikon Transfer was first installed.

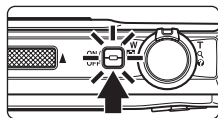

✓ Connecting the USB Cable

- Be sure that connectors are properly oriented. Do not attempt to insert connectors at an angle, and do not use force when connecting or disconnecting the USB cable.
- The connection may not be recognized if the camera is connected to the computer via a USB hub.

- 5** Confirm that the source device is displayed in the transfer options **Source** panel and click **Start Transfer**.

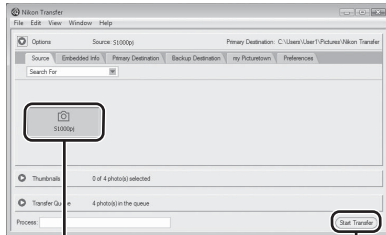

Source device

Start Transfer button

At the Nikon Transfer default settings, all pictures are transferred to the computer.

At the Nikon Transfer default settings, ViewNX starts automatically when transfer is complete and transferred pictures can be viewed.

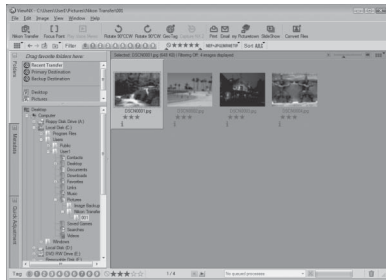

For more information on using Nikon Transfer or ViewNX, refer to help information contained in Nikon Transfer or ViewNX (88).

Disconnecting the camera

Do not turn off the camera or disconnect the camera from the computer during transfer.

When transfer is complete, turn off the camera and disconnect the USB cable.

Using a Card Reader

The pictures stored on the memory card inserted into a card reader or similar device can also be transferred to the computer using Nikon Transfer.

- If the memory card has a capacity greater than 2 GB, or is SDHC-compliant, the intended device must support these features of the memory card.
- Insert a memory card into the card reader or similar device, and refer to the steps 4 and 5 (📖 86) to transfer pictures.
- To transfer pictures stored in the camera's internal memory to the computer, the pictures must first be copied to a memory card using the camera (📖 115).

Starting Nikon Transfer or ViewNX Manually

Windows

Choose **Start menu>All Programs>Nikon Transfer>Nikon Transfer** (or **All Programs>ViewNX>ViewNX**).

Double-clicking the Nikon Transfer or ViewNX shortcut icon on the desktop will also start Nikon Transfer or ViewNX.

Macintosh

Open **Applications** and click **Nikon Software>Nikon Transfer>Nikon Transfer** (or **Nikon Software>ViewNX>ViewNX**).

Clicking the Nikon Transfer or ViewNX icon on the Dock will also start Nikon Transfer or ViewNX.

Viewing Nikon Transfer and ViewNX Help Information

For more information on Nikon Transfer or ViewNX, start Nikon Transfer or ViewNX and select **Nikon Transfer Help** or **ViewNX Help** from the **Help** menu.

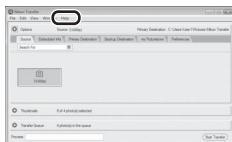

Panorama Creation with Panorama Maker

- Use a series of pictures taken in **Panorama assist** scene mode (📖 42) to create a single panorama photo with Panorama Maker.
- Panorama Maker can be installed on a computer using the supplied Software Suite CD.
- After installation is complete, follow the procedure described below to start Panorama Maker.

Windows

Choose **Start menu>All Programs>ArcSoft Panorama Maker 4>Panorama Maker 4**.

Macintosh

Open **Applications** and double-click the **Panorama Maker 4** icon.

- For more information on using Panorama Maker, refer to the on-screen instructions and help information contained in Panorama Maker.

Image File Names and Folder Names

See "Image/Sound File and Folder Names" (📖 148) for more information.

Connecting to a Printer

Users of PictBridge-compatible (📖 166) printers can connect the camera directly to the printer and print pictures without using a computer.

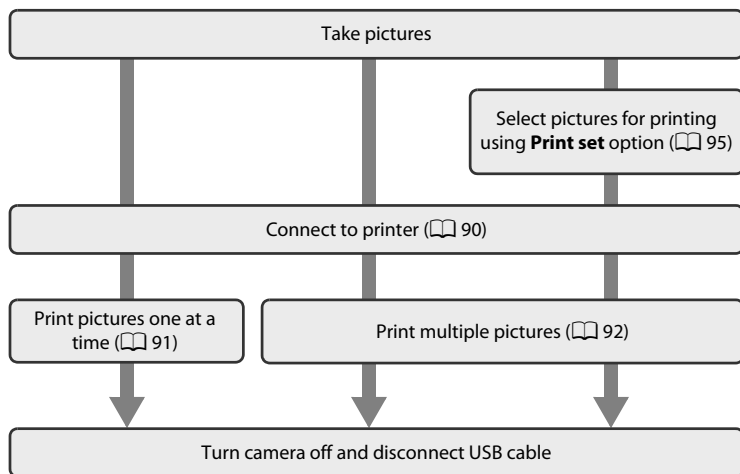

✓ Notes on Power Source

- When connecting the camera to a computer, use a fully charged battery to prevent the camera from turning off unexpectedly.
- If the AC Adapter EH-62F (available separately) is used, COOLPIX S1000pj can be powered from a home electrical outlet. Do not use any other make or model of AC adapter as they may cause the camera to heat up or malfunction.

🔍 Printing Pictures

In addition to printing pictures transferred to a computer and printing over a direct camera-to-printer connection, the following options are also available for printing pictures:

- Insert a memory card into a DPOF-compatible printer's card slot
- Take a memory card to a digital photo lab

For printing using these methods, specify the pictures and the number of prints each to the memory card using the **Print set** option in the playback menu (📖 95).

Connecting the Camera to a Printer

- 1 Turn off the camera.

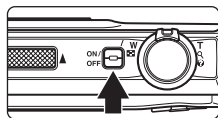

- 2 Turn on the printer.

Check printer settings.

- 3 Connect the camera to the printer using the supplied USB cable.

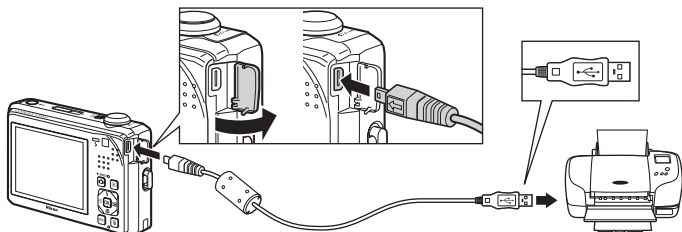

- 4 Turn on the camera.

When properly connected, the **PictBridge** startup screen (①) will be displayed in the camera monitor, followed by the **Print selection** screen (②).

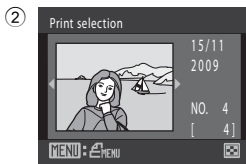
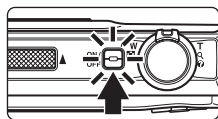

Connecting the USB Cable

When connecting the USB cable, be sure that the connectors are properly oriented. Do not use force when connecting the USB cable. When disconnecting the USB cable, do not pull the connector at an angle.

Printing Pictures One at a Time

After properly connecting the camera to the printer (📖 90), follow the procedure described below to print a picture.

- 1 Use the multi selector to choose the desired picture and press the **OK** button.

Rotate the zoom control to **W** (📷) to switch to 12-thumbnail display, and to **T** (🔍) to switch back to full-frame playback.

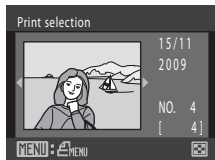

- 2 Choose **Copies** and press the **OK** button.

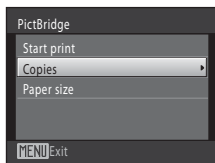

- 3 Choose the number of copies (up to nine) and press the **OK** button.

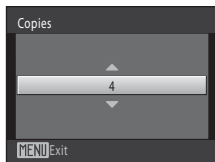

- 4 Choose **Paper size** and press the **OK** button.

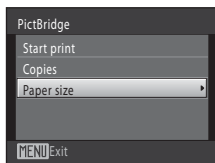

- 5 Choose the desired paper size and press the **OK** button.

To specify paper size using printer settings, choose **Default** in the paper size menu.

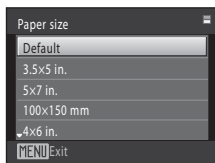

- 6** Choose **Start print** and press the **OK** button.

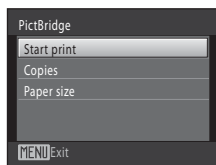

- 7** Printing begins.

Monitor display returns to the print selection screen (step 1) when printing is complete.

To cancel printing before all copies have been printed, press the **OK** button.

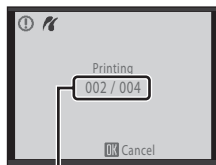

Current print/
total number of prints

Printing Multiple Pictures

After properly connecting the camera to the printer (📖 90), follow the procedure described below to print multiple pictures.

- 1** When the **Print selection** screen is displayed, press the **MENU** button.

The **Print menu** screen is displayed.



- 2** Use the multi selector to choose **Paper size** and press the **OK** button.

To exit the print menu, press the **MENU** button.

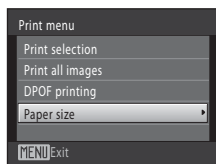

- 3** Choose the desired paper size and press the **OK** button.

To specify paper size using printer settings, choose **Default** in the paper size menu.

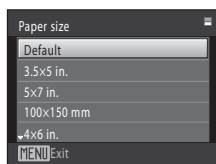

4 Choose **Print selection**, **Print all images** or **DPOF printing** and press the **OK** button.

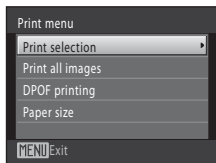

Print selection

Choose pictures (up to 99) and the number of copies (up to nine) of each.

Press the multi selector ◀ or ▶ to select pictures, and press ▲ or ▼ to specify the number of copies for each.

Picture selected for printing can be recognized by the check mark (✓) and the numeral indicating the number of copies to be printed. Check marks are not displayed with pictures for which no copies have been specified and these pictures will not be printed.

Rotate the zoom control to **T** (R) to switch to full-frame playback.

Rotate the zoom control to **W** (W) to switch back to 12-thumbnail display.

Press the **OK** button when setting is complete.

When the menu shown at right is displayed, choose **Start print** and press the **OK** button to start printing.

Choose **Cancel** and press the **OK** button to return to the print menu.

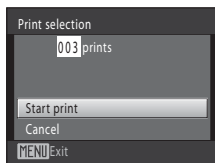

Print all images

One copy each of all pictures stored in the internal memory, or on the memory card, is printed.

When the menu shown at right is displayed, choose **Start print** and press the **OK** button to start print.

Choose **Cancel** and press the **OK** button to return to the print menu.

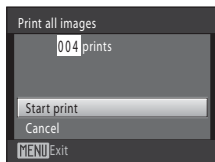

DPOF printing

Print pictures for which a print order was created using the **Print set** option (📖 95). When the menu shown at right is displayed, choose **Start print** and press the **OK** button to start printing.

Choose **Cancel** and press the **OK** button to return to the print menu.

To view the current print order, choose **View images** and press the **OK** button. To print pictures, press the **OK** button again.

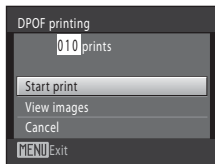
**5** Printing begins.

Monitor display returns to the print menu (step 2) when printing is complete.

To cancel printing before all copies have been printed, press the **OK** button.

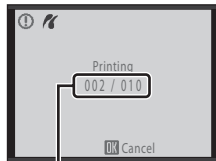

Current print/
total number of prints

📄 Paper Size

The camera supports the following paper sizes: **Default** (the default paper size for the current printer), **3.5×5 in.**, **5×7 in.**, **100×150 mm**, **4×6 in.**, **8×10 in.**, **Letter**, **A3**, and **A4**. Only sizes supported by the current printer will be displayed. To specify paper size using printer settings, choose **Default** in the paper size menu.

Creating a DPOF Print Order: Print Set

The **Print set** option in the playback menu is used to create digital “print orders” for printing on DPOF-compatible devices (📖 166).

When the camera is connected to a PictBridge-compatible printer, pictures can be printed from the printer according to the DPOF print order you have created for pictures on the memory card. If the memory card is removed from the camera, a DPOF print order can be created for pictures stored in the internal memory.

1 Press the **MENU** button in playback mode.

The playback menu is displayed.

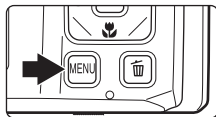

2 Use the multi selector to choose **Print set** and press the **OK** button.

Proceed to step 4 when playing back in list by date mode, auto sort mode, or favorite pictures mode.

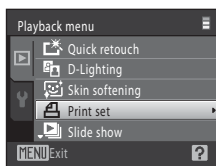

3 Choose **Select images** and press the **OK** button.

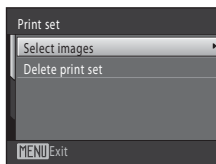

4 Choose pictures (up to 99) and the number of copies (up to nine) of each.

Press the multi selector ◀ or ▶ to select pictures, and press ▲ or ▼ to specify the number of copies to be printed.

Picture selected for printing can be recognized by the check mark (✔) icon and the numeral indicating the number of copies to be printed. Check marks are not displayed with pictures for which no copies have been specified and these pictures will not be printed.

Rotate the zoom control to **T** (🔍) to switch to full-frame playback.

Rotate the zoom control to **W** (🖼️) to switch back to 12-thumbnail display.

Press the **OK** button when setting is complete.





5 Choose whether or not to print shooting date and photo information.

Choose **Date** and press the **OK** button to print the shooting date on all pictures in the print order.

Choose **Info** and press the **OK** button to print shutter speed and aperture information on all pictures in the print order.

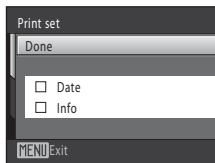
Choose **Done** and press the **OK** button to complete the print order and exit.



Pictures selected for printing are recognized by the  icon displayed with playback.



Notes on Printing with Shooting Date and Photo Information

When the **Date** and **Info** options are enabled in the print set menu, shooting date and photo information are printed on pictures when a DPOF-compatible ( 166) printer which supports printing of shooting date and photo information is used.

- Photo information cannot be printed when the camera is connected directly to a printer, via the supplied USB cable, for DPOF printing ( 94).
- Note that **Date** and **Info** settings are reset when the print set option is displayed.
- The date and time printed on pictures with DPOF printing when **Date** in the **Print set** menu is enabled are those recorded with pictures as they were taken. Date and time printed using this option are not affected when the camera's date and time setting are changed from the setup menu after pictures are recorded.



✓ Notes on Print Set

When a DPOF print order is created in list by date, auto sort, or favorite pictures mode, the screen shown below will be displayed if the following types of pictures were previously marked for printing.

- Pictures taken on dates other than that currently specified
- Pictures sorted to categories other than that currently specified
- Pictures added to albums other than that currently specified

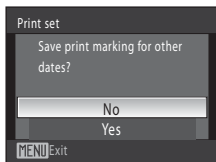

List by date mode

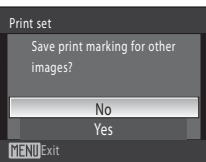

Auto sort mode/favorite pictures mode

- Select **Yes** to add pictures in the selected album or category, or taken on the selected shooting date, to the existing print order.
- Select **No** to remove print marking from previously marked pictures and restrict the print order to pictures in the selected album or category, or taken on the selected shooting date.

If the addition of new pictures to the print order brings the total number of pictures marked for printing to more than 99, the screen shown below will be displayed.

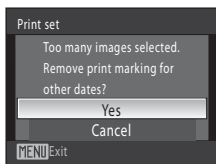

List by date mode

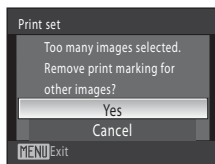

Auto sort mode/favorite pictures mode

- Select **Yes** to remove pictures previously added from the print order and restrict the print order to pictures just marked.
- Select **Cancel** to remove the pictures just added from the print order and restrict the print order to pictures previously marked.

✂ Canceling Existing Print Order

Select **Delete print set** in step 3 and press the **OK** button to remove print marking from all pictures and cancel the print order.











🕒 Date Imprint

When date and time of recording are imprinted on pictures using the **Date imprint** option (📖 125) in setup menu, pictures are recorded with shooting date and time imprinted on the picture when they are taken. Pictures with the date imprinted on them can be printed from printers that do not support printing of the date on pictures.



Only the date and time imprinted on pictures with the date imprint option will be printed, even if the **Print set** date option is enabled.

Shooting Options: The Shooting Menu

The following options can be set when shooting in  (auto) mode ( 22).

	Image mode	 99
	Choose image size and quality. The image mode setting can also be modified from other shooting menus (except the movie menu).	
	White balance	 101
	Match white balance to the light source.	
	Continuous	 103
	Enable continuous shooting or BSS (best shot selector).	
ISO	ISO sensitivity	 104
	Control the camera's sensitivity to light.	
	Color options	 105
	Apply color effects to pictures as they are recorded.	
	AF area mode	 106
	Choose how the camera selects the focus area for autofocus.	

Displaying the Shooting Menu

Enter  (auto) mode ( 22).

Press the **MENU** button to display the shooting menu.

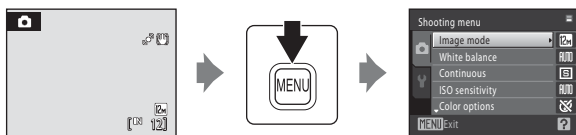

- Use the multi selector to choose and apply settings ( 11).
- To exit the shooting menu, press the **MENU** button.

Camera Settings that Cannot Be Applied Simultaneously

Some functions cannot be enabled in conjunction with others ( 110).

Image Mode











 (auto) → MENU (Shooting menu) →  Image mode

Image mode refers to the combination of image size and image quality (compression) at which pictures are recorded. Choose the image mode best suited to the manner in which pictures will be used and the capacity of the internal memory or memory card. The higher the image mode setting, the larger the size at which it can be printed or displayed without appearing noticeably “grainy,” but limiting the number of pictures that can be recorded.

Option	Size (pixels)	Description
 High (4000★)	4,000 × 3,000	Highest quality, suitable for enlargements or high-quality prints. The compression ratio is approximately 1:4.
 Normal (4000) (default setting)	4,000 × 3,000	Best choice in most situations. The compression ratio is approximately 1:8.
 Normal (3264)	3,264 × 2,448	
 Normal (2592)	2,592 × 1,944	
 Normal (2048)	2,048 × 1,536	Smaller size allows more pictures to be stored. The compression ratio is approximately 1:8.
 PC screen (1024)	1,024 × 768	Suited to display on a computer monitor. The compression ratio is approximately 1:8.
 TV screen (640)	640 × 480	Suited to full-screen display on a television, or distribution by e-mail. The compression ratio is approximately 1:8.
 16:9 (3968)	3,968 × 2,232	Pictures with an aspect ratio of 16:9 are recorded. The compression ratio is approximately 1:8.











The icon for the current setting is displayed in the monitor in shooting and playback modes ( 8, 9).

Image Mode

- Change made to this setting applies to all shooting modes (except the movie mode).
- There may be functions with which this setting cannot be enabled. See “Camera Settings that Cannot Be Applied Simultaneously” ( 110) for more information.

Number of Exposures Remaining



The following table lists the approximate number of pictures that can be stored in internal memory and on a 512 MB memory card. Note that the number of pictures that can be stored will differ depending on the composition of the picture (due to JPEG compression). In addition, this number may vary depending on the make of memory card, even when the memory cards have the same specified capacity.

Setting	Internal memory (approx. 36 MB)	Memory card ¹ (512 MB)	Print size ² (cm/in.)
 High (4000★)	6	85	34 × 25/13.4 × 9.8
 Normal (4000)	12	165	34 × 25/13.4 × 9.8
 Normal (3264)	18	250	28 × 21/11 × 8.3
 Normal (2592)	28	390	22 × 16.5/8.7 × 6.5
 Normal (2048)	45	615	17 × 13/6.7 × 5.1
 PC screen (1024)	154	2100	9 × 7/3.5 × 2.8
 TV screen (640)	289	3945	5 × 4/2 × 1.6
 16:9 (3968)	16	225	34 × 19/13.4 × 7.5

¹ If the number of exposures remaining is 10,000 or more, the number of exposures remaining display shows “9999”.

² All figures are approximate. Print size at an output resolution of 300 dpi. Print sizes are calculated by dividing the number of pixels by printer resolution (dpi) and multiplying by 2.54 cm (1 in.). However, at the same image size, pictures printed at higher resolutions will print smaller than the size indicated, and those printed at lower resolutions will print larger than the size indicated.

WB White Balance

 (auto) → MENU (Shooting menu) →  White balance

The color of light reflected from an object varies with the color of the light source. The human brain is able to adapt to changes in the color of the light source, with the result that white objects appear white whether seen in the shade, direct sunlight, or under incandescent lighting. Digital cameras can mimic this adjustment by processing images according to the color of the light source. This is known as “white balance.” For natural colors, choose a white balance setting that matches the light source before shooting. Although the default setting, **Auto**, can be used under most types of lighting, the white balance setting suited to a particular light source can be specified manually to achieve more accurate results.

Auto (default setting)

White balance automatically adjusted to suit lighting conditions. Best choice in most situations.

Preset manual

Neutral-colored object used as reference to set white balance under unusual lighting conditions. See “Preset Manual” for more information ( 102).

Daylight

White balance adjusted for direct sunlight.

Incandescent

Use under incandescent lighting.

Fluorescent

Use under most types of fluorescent lighting.

Cloudy

Use when taking pictures under overcast skies.

Flash

Use with the flash.

The effects of the selected option can be previewed in the monitor ( 8). At settings other than **Auto**, the icon for the current setting is displayed in the monitor.

Note on White Balance

There may be functions with which this setting cannot be enabled. See “Camera Settings that Cannot Be Applied Simultaneously” ( 110) for more information.

Flash Mode

At white-balance settings other than **Auto** or **Flash**, turn the flash off (  30).

Preset Manual

Preset manual is effective with mixed lighting or to compensate for light sources with a strong color cast (for example, to make pictures taken under a lamp with a red shade look as though they had been taken under white light).

1 Place a white or gray reference object under the lighting that will be used during shooting.

2 Display shooting menu (📖 98), use the multi-selector to choose **PRE Preset manual** in the **White balance** menu and press the **OK** button.

The camera zooms in.

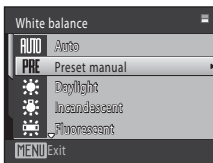

3 Choose **Measure**.

To apply the most recently measured value for preset manual, choose **Cancel** and press the **OK** button.

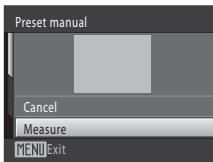

4 Frame the reference object.

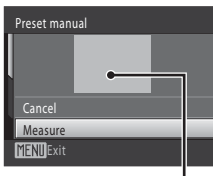

Reference object frame



5 Press the **OK** button.

The shutter is released and the new white-balance value is set. No picture is recorded.

✔ Note on Preset Manual

It is impossible to measure a value for preset manual that takes flash lighting into account. When using flash, select **Auto** or **Flash** for the **White balance** setting.

Continuous

 (auto) → MENU (Shooting menu) →  Continuous

Enable continuous shooting or BSS (best shot selector). The flash is disabled when **Continuous**, **BSS** or **Multi-shot 16** is selected, and focus, exposure and white balance are fixed at the values determined with the first picture in each series.

Single (default setting)

One picture is taken each time the shutter-release button is pressed.

Continuous

While the shutter-release button is held down, up to 4 pictures are taken at a rate of about 0.9 frames per second (fps) when **Image mode** is set to  **Normal (4000)**.

BSS (Best Shot Selector)

The “best shot selector” is recommended when shooting with the flash off or the camera zoomed in, or in other situations in which inadvertent motion can result in blurred pictures. When BSS is on, the camera takes up to ten pictures while the shutter-release button is held down. The sharpest picture in the series is automatically selected and saved.

Multi-shot 16

Each time the shutter-release button is pressed, camera takes 16 shots at about 7.2 fps and arranges them in a single images.

- **Image mode** is set to  **Normal (2592)**.
- Digital zoom is not available.



At settings other than **Single**, the indicator for the current setting is displayed in the monitor ( 8).

Notes on Continuous Shooting

- The maximum frame rate with continuous shooting may vary depending upon the current image mode setting, the memory card used, or shooting condition.
- There may be functions with which this setting cannot be enabled. See “Camera Settings that Cannot Be Applied Simultaneously” ( 110) for more information.



Note on BSS

BSS may not produce the desired results if the subject moves or the composition changes while the shutter-release button is held down.

Note on Multi-shot 16

Smear ( 151) visible in the monitor when shooting with **Multi-shot 16** enabled will be recorded with images. Avoiding bright objects such as the sun, reflections of the sun, and electric lights when shooting with **Multi-shot 16** enabled is recommended.

ISO ISO Sensitivity

 (auto) → MENU (Shooting menu) →  ISO sensitivity

Sensitivity is a measure of the camera's response to light. The higher the sensitivity, the less light is needed to expose an image. Although high ISO sensitivity settings are suited to pictures of moving subjects or those taken under dim lighting, high sensitivity settings are often associated with "noise" - randomly spaced, brightly colored pixels - concentrated in dark portions of the image.

Auto (default setting)

Sensitivity is ISO 80 under normal conditions; when lighting is poor and the flash is off, the camera compensates by raising sensitivity to a maximum of ISO 800.





Fixed range auto

Choose the range in which the camera automatically adjusts ISO sensitivity, from **ISO 80-200** (default setting) or **ISO 80-400**. The camera will not increase sensitivity beyond the maximum value in the selected range. Specify the maximum ISO sensitivity for effective control over the amount of "grain" that appears in images.

80, 100, 200, 400, 800, 1600, 3200, 6400

Sensitivity is locked at the specified value.



Motion detection ( 127) does not function when any option other than **Auto** is selected in the ISO sensitivity setting.

At the settings other than **Auto**, the current setting is displayed in the monitor ( 8). If **Auto** is selected and the sensitivity is raised above ISO 80, the  icon will be displayed ( 31). When **Fixed range auto** is selected,  and the maximum value of ISO sensitivity is displayed.



Note on ISO Sensitivity

There may be functions with which this setting cannot be enabled. See "Camera Settings that Cannot Be Applied Simultaneously" ( 110) for more information.





Note on ISO Sensitivity 3200 and 6400

When shooting with **ISO sensitivity** set to **3200** or **6400**,  **Normal (2048)**,  **PC screen (1024)**, and  **TV screen (640)** can be set for the **Image mode** setting. The image mode indicator on the monitor in shooting mode turns red.

Color Options

 (auto) → MENU (Shooting menu) →  Color options

Make colors more vivid or record pictures in monochrome.

-  **Standard color (default setting)**
Use for pictures exhibiting natural color.
-  **Vivid color**
Use to achieve a vivid, “photoprint” effect.
-  **Black-and-white**
Record pictures in black-and-white.
-  **Sepia**
Record pictures in sepia tones.
-  **Cyanotype**
Record pictures in cyan-blue monochrome.

The effects of the selected option can be previewed in the monitor. At settings other than **Standard color**, the icon for the current setting is displayed in the monitor ( 8). Monitor color tones also change depending upon the setting.

Note on Color Options

There may be functions with which this setting cannot be enabled. See “Camera Settings that Cannot Be Applied Simultaneously” ( 110) for more information.

[+/-] AF Area Mode

📷 (auto) → MENU (Shooting menu) → [+/-] AF area mode

Use this option to determine how the camera selects the focus area for autofocus. When digital zoom is in effect, the camera always focuses at the center of the frame regardless of the specified setting.

👤 Face priority (default setting)

When the camera recognizes a human face, it focuses on that face. See “Face Priority” (📖 108) for more information. If more than one face is recognized, the camera focuses on the face closest to the camera.

When taking pictures of subjects other than people, or framing a subject with which no face is recognized, the **AF area mode** setting switches to **Auto**, and the camera will automatically select the focus area (one of nine) containing the subject closest to the camera.

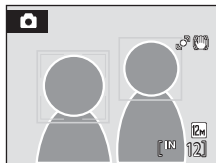

📷 Auto

Camera automatically selects the focus area (one of nine) containing the subject closest to the camera. Press the shutter-release button halfway to activate the focus area. When the shutter-release button is pressed halfway, the focus area selected by the camera will be displayed in the monitor.

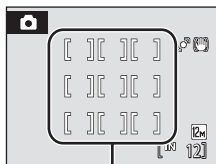

Focus areas

[+/-] Manual

This option is suited to situations in which the intended subject is relatively still and not positioned in the center of the frame.

Press the multi selector ▲, ▼, ◀, or ▶ to select one of 99 focus areas displayed in the monitor's focus-area selection screen, and shoot.

To end focus-area selection and adjust the flash, macro, self-timer and exposure compensation settings, press the OK button. To return to the focus area selection screen, press the OK button again.

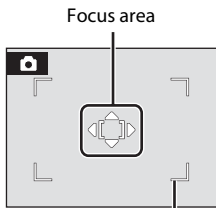

Selectable focus area

Center

The camera focuses on the subject at the center of the frame.
The center focus area is always displayed.

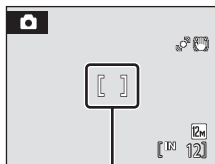

Focus area

Focus Lock

To focus on off-center subjects when **Center** is selected for **AF area mode**, use focus lock as described below.

- 1 Position the subject in the center of the frame.
- 2 Press the shutter-release button halfway.
 - Confirm that the focus area is green.
 - Focus and exposure are locked.
- 3 Continue holding down the shutter-release button halfway and recompose the picture.
 - Be sure that the distance between the camera and the subject does not change.
- 4 Press the shutter-release button the rest of the way down to take the picture.

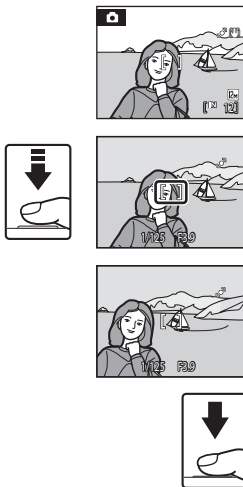

More Information

See "Autofocus" (📖 27) for more information.

Face Priority

When the camera is pointed at a human face, face recognition, which the camera automatically recognizes that face and focus on it, starts. The face priority function is activated in the following situations.

- **AF area mode** (📖 106) is set to **Face priority**
- In **Scene auto selector** (📖 37), **Portrait** (📖 37) and **Night portrait** (📖 38) scene modes
- In smart portrait mode (📖 49)

1 Frame a picture.

When the camera recognizes a face, that face is framed by a yellow double border.

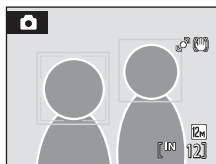

When the camera recognizes more than one face, operation varies as follows depending upon the shooting mode.

Shooting mode	Faces framed by double border	Number of faces that can be recognized
📷 (auto) mode (Face priority) Scene auto selector, Portrait, Night portrait scene mode	The face closest to the camera * The other faces are framed by a single border.	Up to 12
Smart portrait mode	The face closest to the center of the frame * The other faces are framed by a single border.	Up to 3

2 Press the shutter-release button halfway.

The camera focuses on the face framed by the double border. The double border turns green and focus is locked. When the camera is unable to focus, the double border will blink. Press the shutter-release button halfway again and focus.

Press the shutter-release button the rest of the way down to take a picture.

If the camera detects that the face framed by the double border is smiling in smart portrait mode, the **Smile timer** (📖 49) is activated and the shutter is automatically released without the shutter-release button having been pressed.

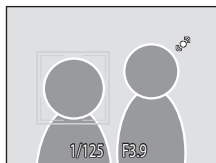









Notes on Face Priority

- If the camera is unable to recognize any faces when the shutter-release button is pressed halfway with **AF area mode** set to **Face priority**, the AF area mode setting automatically switches to **Auto**.
- If no faces are recognized when the shutter-release button is pressed halfway in **Portrait** or **Night portrait** scene mode or smart portrait mode, the camera will focus on the subject at the center of the frame.
- The camera may be unable to recognize faces in the following situations:
 - When faces are partially hidden by sunglasses or otherwise obstructed
 - When faces take up too much or too little of the frame
- When the frame includes more than one face, the faces recognized by the camera and the face on which the camera focuses depend upon a variety of factors, including the direction in which the faces are looking.
- In some rare cases, the subject may not be in focus despite the fact that the double border glows green (📖 27). Should this occur, switch to  (auto) mode and set **AF area mode** to **Manual** or **Center**, refocus on another subject positioned at the same distance from the camera as the actual portrait subject, and use focus lock (📖 107).
- When pictures in which a face was detected during shooting are played back, the pictures will be, automatically rotated for playback display, according to the orientation of the face detected except pictures that were taken using **Continuous, BSS** and **Multi-shot 16** (📖 103).











Camera Settings that Cannot Be Applied Simultaneously

Some shooting settings cannot be used with other functions.

Restricted function	Setting	Descriptions
 Flash (📖 30)	Continuous (📖 103)	When Continuous , BSS , or Multi-shot 16 is selected, flash is disabled.
 Image mode (📖 99)	Continuous (📖 103)	When Multi-shot 16 is selected, the Image mode setting is fixed at 📷 Normal (2592) .
	ISO sensitivity (📖 104)	When 3200 or 6400 is selected for ISO sensitivity , the image mode setting of 📷 Normal (2048) , 📺 PC screen (1024) , or 📺 TV screen (640) can be selected. If any Image mode setting other than above is selected, the image mode setting is automatically changed to 📷 Normal (2048) when ISO sensitivity is set to 3200 or 6400 .
 White balance (📖 101)	Color options (📖 105)	When Black-and-white , Sepia , or Cyanotype is selected for Color options , the White balance setting is fixed at Auto .
 Continuous (📖 103)	Self-timer (📖 32)	When taking a picture using the self-timer, Continuous , BSS , and Multi-shot 16 are disabled.
 ISO sensitivity (📖 104)	Continuous (📖 103)	When Multi-shot 16 is selected, the ISO sensitivity setting is automatically specified according to the brightness.
 Date imprint (📖 125)	Continuous (📖 103)	When taking a picture using Continuous or BSS , date cannot be imprinted.
 Motion detection (📖 127)	Continuous (📖 103)	When Multi-shot 16 is selected, Motion detection is not enabled.
	ISO sensitivity (📖 104)	When the option other than Auto is selected for ISO sensitivity, Motion detection is disabled.
 Blink warning (📖 132)	Continuous (📖 103)	When taking a picture using Continuous , BSS , or Multi-shot 16 , Blink warning is disabled.

Playback Options: The Playback Menu

The following options are available in the playback menu.

	Quick retouch 📖 75
Easily create retouched copies in which contrast and saturation have been enhanced.	
	D-Lighting 📖 76
Enhances brightness and contrast in dark portions of pictures.	
	Skin softening 📖 77
The camera detects faces and creates a copy of the picture with softer skin tones in the faces of portrait subjects.	
	Print set 📖 95
Select pictures to print and the number of copies for each.	
	Slide show 📖 113
View pictures stored in the internal memory or on a memory card in an automatic slide show.	
	Delete 📖 114
Delete all or selected pictures.	
	Protect 📖 114
Protect selected pictures from accidental deletion.	
	Rotate image 📖 115
Change the orientation of pictures.	
	Small picture 📖 79
Create a small copy of the current picture.	
	Voice memo 📖 71
Record voice memos for pictures.	
	Copy 📖 115
Copy files between memory card and internal memory.	

Displaying the Playback Menu

Press the  button to enter playback mode (📖 28).

Press the **MENU** button to display the playback menu.

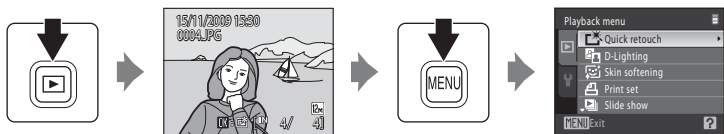

- Use the multi-selector to choose and apply settings (📖 11).
- Press the **MENU** button to exit the playback menu.

Selecting Pictures

The picture selection screen like that shown at right is displayed with the following menu selections:

- Playback menu: **Print set>Select images** (📖 95), **Delete>Erase selected images** (📖 114), **Protect** (📖 114), **Rotate image** (📖 115), **Copy>Selected images** (📖 115)
- Setup menu: **Welcome screen>Select an image** (📖 120)



Follow the procedures described below to choose the pictures.

- 1** Press the multi selector ◀ or ▶ to choose the desired picture.

Only one picture can be selected at a time for **Rotate image** and **Welcome screen**. Proceed to step 3.

Rotate the zoom control to **T** (🔍) to switch to full-frame playback or **W** (📐) to switch back to 12-thumbnail display.



- 2** Press ▲ or ▼ to select or deselect (or to specify the number of copies).

When a picture is selected, a check mark (✔) is displayed with the picture. Repeat steps 1 and 2 to select additional pictures.



- 3** Press the Ⓞ button to finalize selection.

Slide Show

 button (Playback mode) → MENU (Playback menu) →  Slide show

Play back pictures stored in the internal memory or on a memory card one by one in an automated “slide show.”

1 Use the multi selector to choose **Start** and press the button.

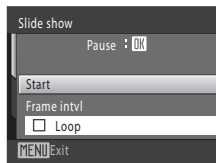

To change the interval between pictures, choose **Frame intvl**, select the desired interval time, and press the  button before choosing **Start**.

To repeat the slide show automatically, enable **Loop** and press the  button before choosing **Start**. The check mark (✓) will be added to the loop option when enabled.



2 The slide show begins.

While the slide show is in progress, the following operations are available:

Press the multi selector  to display the subsequent picture or  to display the previous picture. Hold down either button to fast forward or rewind.

Press the  button to pause the slide show.



3 Choose **End** or **Restart**.

When the slide show ends or is paused, choose **End** and press the  button to return to the playback menu, or choose **Restart** to play the slide show again.

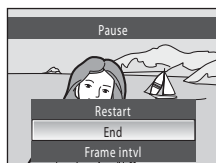

Notes on Slide Show

- Only the first frame of movies (📖 83) included in a slide show is displayed.
- The maximum playback time is up to 30 minutes even if **Loop** is enabled (📖 129).

Delete

 button (Playback mode) → MENU (Playback menu) →  Delete

Delete selected pictures or all pictures.

Erase selected images

Select a picture in the picture selection screen and delete the image. See “Selecting Pictures” ( 112) for more information.

Erase all images

Delete all pictures.

Notes on Deletion

- Once deleted, pictures cannot be recovered. Transfer important images to a computer before deletion.
- Pictures marked with the  icon are protected and cannot be deleted.



Protect

 button (Playback mode) → MENU (Playback menu) →  Protect



Protect selected pictures from accidental deletion.

Choose pictures in the picture selection screen to apply the protect option. See “Selecting Pictures” ( 112) for more information.

Note that formatting the camera’s internal memory or the memory card will permanently delete protected files ( 130).

Protected pictures are recognized by the  icon ( 9, 54).

Rotate Image

 button (Playback mode) → MENU (Playback menu) →  Rotate image

Specify the orientation in which recorded pictures are displayed with playback. Still pictures can be rotated 90 degrees clockwise or 90 degrees counterclockwise. Pictures that were recorded in portrait (“tall”) orientation can be rotated up to 180 degrees in either direction.

Select a picture in the picture selection screen ([112](#)). When the **Rotate image** screen is displayed, press the multi selector ◀ or ▶ to rotate the picture 90°.

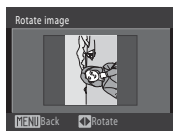

Rotate 90°
counterclockwise

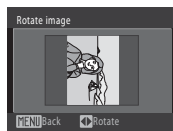

Rotate 90° clockwise

Press the  button to finalize display orientation, and save orientation data with the picture.

Copy

 button (Playback mode) → MENU (Playback menu) →  Copy

Copy pictures between the internal memory and a memory card.

- Use the multi selector to select an option from the copy screen and press the  button.

 → : Copy pictures from internal memory to memory card.

 → : Copy pictures from memory card to internal memory.



2 Select a copy option and press the **OK** button.

Selected images: Copy pictures selected from the picture selection screen (📖 112).

All images: Copy all pictures.

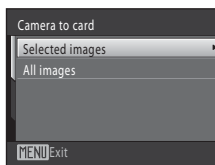

✓ **Notes on Copying Pictures**

- JPEG-, AVI-, and WAV-format images can be copied. Images recorded in any other format cannot be copied.
- If voice memos (📖 71) are attached to pictures selected for copying, voice memos are copied with the pictures.
- Pictures taken with another make of camera or that have been modified on a computer cannot be copied.
- When copying pictures selected for a **Print set** (📖 95), the print set marking is not copied. However, **Protect** (📖 114) settings are copied with pictures.
- Pictures copied from the internal memory or a memory card cannot be displayed in auto sort mode (📖 61).
- When pictures added to albums (📖 66) are copied, the copies are not automatically added to the same albums as the original pictures.

📎 **“Memory contains no images.” Message**

If there are no pictures stored on the memory card when playback mode is applied, the message **Memory contains no images.** will be displayed. Press the **MENU** button to display the copy option screen, and copy the pictures stored in the camera’s internal memory to the memory card.













📖 **More Information**

See “Image/Sound File and Folder Names” (📖 148) for more information.



Basic Camera Setup: The Setup Menu

In shooting/playback mode, the following options can be applied for the setup menu.

- See “The Projector Settings Menu” (📖 144) for more information on basic settings in projector mode.

	Menus 📖 119
	Choose how menus are displayed.
	Welcome screen 📖 120
	Select screen displayed when camera is turned on.
	Date 📖 121
	Set camera clock and choose home and destination time zones.
	Monitor settings 📖 124
	Adjust photo information display, post-shooting image review, and monitor brightness settings.
	Date imprint 📖 125
	Imprint date on pictures.
	Vibration reduction 📖 126
	Choose whether or not vibration reduction is enabled when taking still pictures.
	Motion detection 📖 127
	Enable or disable motion detection, which reduces the effects of subject movement and camera shake in still pictures.
	AF assist 📖 128
	Enable or disable AF-assist illumination.
	Digital zoom 📖 128
	Enable or disable digital zoom.
	Sound settings 📖 129
	Adjust sound settings.
	Auto off 📖 129
	Set time before camera enters standby mode for saving power.
	Format memory/Format card 📖 130
	Format internal memory or memory card.
	Language 📖 131
	Choose the language used for camera monitor display.

Basic Camera Setup: The Setup Menu

	Video mode 📖 131
	Adjust settings necessary for connection to television.
	Blink warning 📖 132
	Specify whether or not the camera detects human subjects that have blinked with shooting using face priority.
	Reset all 📖 134
	Restore camera settings to the default.
Ver.	Firmware version 📖 136
	Display camera firmware version.

Displaying the Setup Menu

Display the menu screen in shooting mode or playback mode and select **Y** (setup) tab in the menu screen.

- 1 Press the **MENU** button to display the menu screen.

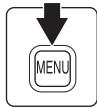

 (auto)mode, smart portrait mode, and playback mode

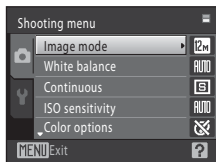

Scene mode, subject tracking mode, and movie mode

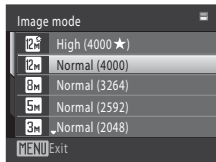

- 2 Press the multi selector **◀**.

Tab selection is activated.

See “The Multi Selector” (📖 11) for more information.

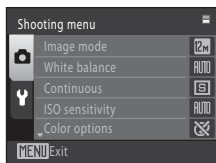

3 Press ▲ or ▼ to select the Y tab.

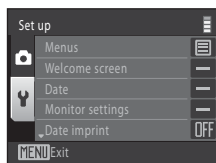

4 Press ► or the OK button.

The setup menu items can be selected.

Use the multi selector to choose items and adjust menu options (111).

To exit the setup menu, press the MENU button or ◀ to select the shooting or playback tab.

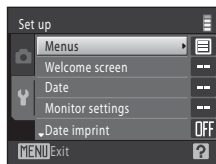

MENU Menu

MENU button → Y (Setup menu) (118) → MENU Menu

Choose the initial menu displayed.

Text (default setting)

Menus are displayed in list format.

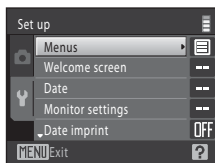



Icons

All menu items can be displayed in a single screen.

Menu names



Welcome Screen

MENU button →  (Setup menu) (📖 118) →  Welcome screen

Select the welcome screen to be displayed when the camera is turned on.

None (default setting)

No welcome screen will be displayed.

COOLPIX



Displays a welcome screen.

Select an image

Access the picture selection screen to choose a picture (📖 112) from the internal memory or the memory card for the welcome screen, and press the  button. As the selected picture is stored by the camera, it will be displayed when the camera is turned on even if the original picture is deleted.

Pictures taken at an **Image mode** (📖 99) setting of  **16:9 (3968)**, and copies created at a size of 320 × 240 or smaller using the small picture (📖 79) or crop (📖 80) function, cannot be used.

Date

MENU button →  (Setup menu) (📖 118) →  Date

Set the camera clock.



Date

Set camera clock to current date and time.

Use the multi selector to set the date and time in the date screen.

- Highlight a different item (day, month, year, hour, minute, and the order in which day, month, and year are displayed): press ◀ or ▶.
- Edit the highlighted item: press ▲ or ▼.
- Apply the setting: select the order in which day, month, and year are displayed and press the  button (📖 19).

Time zone

 (home time zone) can be specified and daylight saving enabled or disabled from **Time zone** options. When the destination time zone () is selected, local time (📖 123) is automatically calculated and date and time in the selected region are recorded with pictures. Useful when travelling.

Selecting Travel Destination Time Zone

- 1 Use the multi selector to choose **Time zone** and press the  button.

The **Time zone** menu is displayed.

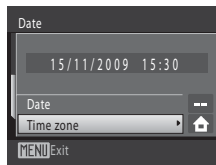

- 2 Choose  **Travel destination** and press the  button.

The date and time displayed in the monitor change according to the region currently selected.

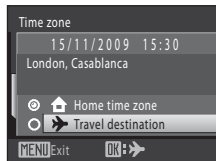

3 Press **▶**.

The time zone selection screen is displayed.

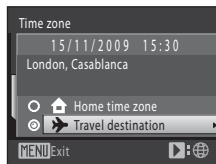

4 Press **◀** or **▶** to choose the travel destination time zone.

Press **▲** in a time zone where daylight saving is in effect to enable the daylight saving time function and automatically advance the time by one hour. The  icon will be displayed at the top of the monitor. Press **▼** to disable the daylight saving time function.

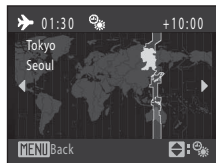

Press the **OK** button to choose the travel destination time zone.

While the travel destination time zone is selected, the  icon will be displayed in the monitor when the camera is in shooting mode.

The Clock Battery

The camera's internal clock uses a different battery from that used to power camera operation. The clock battery charges when the main battery is inserted or an AC adapter (available separately) is connected, and can provide several days of backup power after about ten hours of charging.

Home Time Zone

- To switch to the home time zone, choose **Home time zone** in step 2 and press the **OK** button.
- To change the home time zone, choose **Home time zone** in step 2 and complete steps 3 and 4.

Daylight Saving Time

When daylight saving time starts or ends, turn the daylight saving time function on or off from the time zone selection screen displayed in step 4.

Imprinting the Date on Pictures



Enable date imprint from the **Date imprint** option ( 125) in the setup menu after the date and time have been set. When the **Date imprint** option is enabled, pictures will be recorded with shooting date imprinted on them.

 **Time Zones**

The camera supports the time zones listed below. For time zone not listed below, set the camera clock to local time.

UTC +/-	Location	UTC +/-	Location
-11	Midway, Samoa	+1	Madrid, Paris, Berlin
-10	Hawaii, Tahiti	+2	Athens, Helsinki, Ankara
-9	Alaska, Anchorage	+3	Moscow, Nairobi, Riyadh, Kuwait, Manama
-8	PST (PDT): Los Angeles, Seattle, Vancouver	+4	Abu Dhabi, Dubai
-7	MST (MDT): Denver, Phoenix	+5	Islamabad, Karachi
-6	CST (CDT): Chicago, Houston, Mexico City	+5.5	New Delhi
-5	EST (EDT): New York, Toronto, Lima	+6	Colombo, Dhaka
-4	Caracas, Manaus	+7	Bangkok, Jakarta
-3	Buenos Aires, Sao Paulo	+8	Beijing, Hong Kong, Singapore
-2	Fernando de Noronha	+9	Tokyo, Seoul
-1	Azores	+10	Sydney, Guam
±0	London, Casablanca	+11	New Caledonia
		+12	Auckland, Fiji

Monitor Settings

MENU button →  (Setup menu) (📖 118) →  Monitor settings

Set the options below.

Photo info

Choose information displayed in the monitor during shooting and playback mode.

Image review

On (default setting): Picture is automatically displayed in the monitor immediately after it is taken and the monitor display returns to shooting mode.

Off: Picture is not displayed after it is taken.





Brightness

Choose from five settings for monitor brightness. The default setting is **3**.

Photo Info

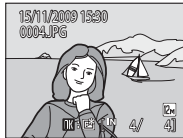
The following display options are available.

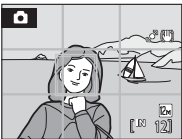
See “The Monitor” (📖 8) for information on indicators displayed in the monitor.

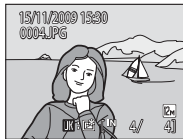
	Shooting mode	Playback mode
Show info		
Auto info (default setting)	The current settings or operation guide is displayed for a few seconds, as in Show info above. After a few seconds, display will be the same as Hide info .	
Hide info		
Framing grid	 In addition to information shown with Auto info above, a framing grid is displayed to help frame pictures in  (auto) mode. In other shooting modes only the information shown with Auto info is displayed.	 The current settings or operation guide is displayed, as in Auto info above.

DATE Date Imprint

MENU button → **Y** (Setup menu) (📖 118) → **DATE** Date imprint

The shooting date and time can be imprinted on the pictures with shooting, allowing the information to be printed even from printers that do not support date printing (📖 96).



Off (default setting)

Date and time are not imprinted on pictures.

Date

Date is imprinted on the pictures.

Date and time

Date and time are imprinted on the pictures.

At settings other than **Off**, the icon for the current setting is displayed in the monitor (📖 8).

✓ Date Imprint

- Imprinted dates form a permanent part of image data and cannot be deleted. Date cannot be imprinted on pictures after they are taken.
- Dates imprinted at an **Image mode** setting (📖 99) of **TV screen (640)** may be difficult to read. Choose **PC screen (1024)** or larger when using date imprint.
- The date is recorded using the format selected in the setup menu's **Date** item (📖 18, 121).
- The date is not imprinted in the following situations:
 - Pictures taken in **Sports**, **Museum**, or **Panorama assist** scene mode
 - **Blink proof** (📖 51) is set to **On** in smart portrait mode
 - Pictures taken with **Continuous** or **BSS** selected for the **Continuous** setting in the shooting menu (📖 103)
 - Movie mode

📎 Date Imprint and Print Set

When printing from DPOF-compatible printers that support the printing of shooting date and photo information, the date and information can be printed without imprinting this information on them using options in the **Print set** menu (📖 95).

Vibration Reduction

MENU button →  (Setup menu) (📖 118) →  Vibration reduction

Choose a vibration reduction option for shooting.

Vibration reduction effectively reduces blur caused by slight hand movement known as camera shake, which commonly occurs when shooting with zoom applied or at slow shutter speeds. The effects of camera shake are reduced when recording movies, in addition to when taking still pictures.

Set **Vibration reduction** to **Off** when using a tripod to stabilize the camera during shooting.

On (hybrid)

The effects of camera shake are reduced optically using a lens-shift method. Additional image processing with electronic vibration reduction is applied to further reduce the effects of camera shake with recording of still pictures taken under the following conditions.

- When the flash does not fire
- When a shutter speed slower than 1/60 seconds is used
- When **Self-timer** is disabled
- When **Continuous** is set to **Single**
- When ISO sensitivity is set to 200 or less

On (default setting)

The vibration reduction method using the lens-shift method only is enabled.

Off



Vibration reduction is not enabled.

The current vibration reduction setting can be confirmed in the camera monitor with shooting (📖 8, 23). When **Off** is selected, no icon is displayed.

Notes on Vibration Reduction

- Vibration reduction may take a few seconds to activate after the power is turned on, or the camera enters shooting mode from playback mode. Wait until the image of the monitor stabilizes before shooting.
- Due to characteristics of the vibration reduction function, images displayed in the camera's monitor immediately after shooting may be displayed blurry.
- Vibration reduction may be unable to completely eliminate the effects of camera shake in some situations.
- Image processing with electronic vibration reduction may not perform as expected with very slight or extreme camera shake, even when **On (hybrid)** is selected.
- Image processing with electronic vibration reduction is not enabled at fast or extremely slow shutter speeds, even when **On (hybrid)** is selected.
- When **On (hybrid)** is selected and electronic vibration reduction is activated, the shutter is automatically released twice when a picture is taken to allow for image processing. Therefore, the time required to record pictures increases. **Shutter sound** (📖 129) can be heard only when the shutter is released the first time and a single picture will be recorded.

Motion Detection



MENU button →  (Setup menu) (📖 118) →  Motion detection

Enable motion detection to reduce the effects of subject movement and camera shake when shooting still pictures.

Auto (default setting)

When the camera detects subject movement or camera shake, the shutter speed is automatically increased to reduce blurring.

However, motion detection does not function in the following situations.

- When the flash mode is set to  (fill flash)
- When **ISO sensitivity** (📖 104) is set to **Fixed range auto** or ISO sensitivity is fixed at a particular value in  (auto) mode
- When **Multi-shot 16** (📖 103) is enabled
- When **Sports, Night portrait, Dusk/dawn, Night landscape, Museum, Fireworks show, or Backlight** scene mode is enabled
- When subject tracking mode is enabled

Off

Motion detection is not enabled.

The current motion detection setting can be confirmed in the camera monitor with shooting (📖 8, 23). The motion detection icon turns green when the camera detects camera shake and increases shutter speed. When **Off** is selected, no icon is displayed.

Notes on Motion Detection

- Motion detection may be unable to completely eliminate the effects of subject movement and camera shake in some situations.
- Motion detection may not function if the subject exhibits significant movement or is too dark.
- The pictures taken using motion detection may be somewhat “grainy” in appearance.

AF Assist

MENU button →  (Setup menu) ( 118) →  AF assist

Enable or disable AF-assist illumination.



Auto (default setting)

AF-assist illumination is used to assist the focus operation when the subject is poorly lit. The illuminator has a range of about 5 m (16 ft.). Note that for some scene modes, AF-assist illuminator turns off automatically ( 37 – 42).

Off

AF-assist illumination is disabled. The camera may be unable to focus if lighting is poor.

Digital Zoom

MENU button →  (Setup menu) ( 118) →  Digital zoom

Enable or disable digital zoom.



On (default setting)

When the camera is zoomed in to the maximum optical zoom position, rotating the zoom control to **T** triggers digital zoom ( 25).

Off

Digital zoom will not be activated (except when recording movies).

Notes on Digital Zoom

- When digital zoom is in effect, **AF area mode** is set to **Center** ( 106).
- Digital zoom cannot be used in the following situations.
 - When **Scene auto selector**, **Portrait**, or **Night portrait** is selected in scene mode
 - When smart portrait mode is selected
 - When subject tracking mode is selected
 - When **Continuous** is set to **Multi-shot 16** ( 103)
 - Just before recording a movie (Up to 2x zoom can be activated while recording movies)

🔊 Sound Settings

MENU button →  (Setup menu) (📖 118) → 🔊 Sound settings

Adjust the following sound settings.

Button sound

Turn button sound **On** or **Off**.

When **On** (default setting) is selected, a beep will sound once when operations are completed successfully, twice when focus has been locked, and three times when an error is detected. Start-up sound will also play when the camera is turned on.

Shutter sound

Turn shutter sound **On** (default setting) or **Off**.

🕒 Auto Off

MENU button →  (Setup menu) (📖 118) → 🕒 Auto off

When the camera is on and a specified period of time passes with no operations performed, the monitor turns off and the camera will enter standby mode (📖 17) to save power. Once the camera has entered standby mode, the power-on lamp will blink, and if no operations are performed for another three minutes, the camera will turn off.

Choose the time allowed to elapse before the camera enters standby mode if no operations are performed from **30 s**, **1 min** (default setting), **5 min**, and **30 min**.

✏️ Canceling Standby Mode

Cancel standby mode and reactivate the monitor by pressing any of the following buttons.

- the power switch
- the shutter-release button
- the  button
- the  button





✏️ Note on Auto Off

Regardless of the option selected, the monitor will remain on for three minutes when menus are displayed, a maximum of 30 minutes during slide show playback, and 30 minutes when the AC adapter is connected.

✏️ Auto Off in Projector Mode

Use the **Auto off** (📖 145) option in the projector settings menu to specify the auto off setting for projector mode.

Format Memory/ **Format Card**

MENU button →  (Setup menu) ( 118) →  Format memory/  Format card

Use this option to format the internal memory or a memory card.

Formatting the Internal Memory

To format the internal memory, remove the memory card from the camera.

The **Format memory** option is displayed in the setup menu.

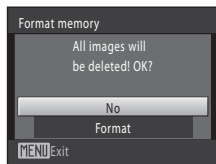

Formatting a Memory Card

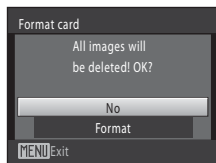

When the memory card is inserted in the camera, the **Format card** option is displayed in the setup menu.



Formatting Internal Memory and Memory Cards

- **Formatting the internal memory or memory cards permanently deletes all data.** Be sure to transfer important pictures to a computer before formatting.
- Formatting the internal memory or memory card restores album icon settings ( 65) to the default setting (displayed as number).
- Do not turn the camera off, or open the battery-chamber/memory card slot cover during formatting.
- Be sure to use this camera to format memory cards previously used in other devices the first time they are inserted into the COOLPIX S1000pj.

Language



MENU button →  (Setup menu) (📖 118) →  Language

Choose one of 24 languages for display of camera menus and messages.

Čeština	Czech
Dansk	Danish
Deutsch	German
English	(default setting)
Español	Spanish
Ελληνικά	Greek
Français	French
Indonesia	Indonesian
Italiano	Italian
Magyar	Hungarian
Nederlands	Dutch
Norsk	Norwegian



Polski	Polish
Português	Portuguese
Русский	Russian
Suomi	Finnish
Svenska	Swedish
Türkçe	Turkish
中文简体	Simplified Chinese
中文繁體	Traditional Chinese
日本語	Japanese
한글	Korean
ภาษาไทย	Thai
عربي	Arabic

Video Mode

MENU button →  (Setup menu) (📖 118) →  Video mode

Adjust settings for connection to a television. Choose from **NTSC** and **PAL**.

Blink Warning

MENU button →  (Setup menu) (📖 118) →  Blink warning

Choose whether or not the camera detects human subjects that have blinked using face priority when shooting in the following modes.

-  (auto) mode (when **Face priority** (📖 106) is selected for AF area mode option).
- **Scene auto selector** (📖 37), **Portrait** (📖 37), or **Night portrait** (📖 38) is selected for the scene mode.

On

When the camera detects that one or more human subjects may have blinked in a picture taken using face priority, the **Did someone blink?** dialog is displayed in the monitor.

The face of the human subject that may have blinked when the shutter was released is framed by a yellow border. Should this occur, check the picture and determine whether or not another picture should be taken.

See "Operating the Blink Warning Screen" (📖 133) for more information.

Off (default setting)

Blink warning is not enabled.

Operating the Blink Warning Screen

When the **Did someone blink?** dialog is displayed with shooting, the following operations can be performed.

If no operations are performed within a few seconds, the camera automatically returns to shooting mode.



Option	Use	Description
Enlarge display of the face that blinked	T (Q)	Rotate the zoom control to T (Q).
Switch to full-frame playback	W (checkered flag)	Rotate the zoom control to W (checkered flag).
Select the face to be displayed		If the camera detects that more than one human subject blinked, press ▲, ▼, ◀ or ▶ with display zoomed in to switch to another face.
Delete the picture		Press the button.
Switch to shooting mode		Press the button or the shutter-release button.

Note on Blink Warning

The blink warning does not function at continuous settings of **Continuous**, **BSS** or **Multi-shot 16**.

Reset All

MENU button →  (Setup menu) (📖 118) →  Reset all

When **Reset** is selected, the camera's settings will be restored to their default values.

Basic Shooting Functions

Option	Default value
Flash mode (📖 30)	Auto
Self-timer (📖 32)	Off
Macro mode (📖 33)	Off
Exposure compensation (📖 34)	0.0

Scene Mode

Option	Default value
Scene mode setting in the shooting-mode selection menu (📖 36)	Scene auto selector
White balance in Food mode (📖 45)	Center

Smart Portrait Menu

Option	Default value
Skin softening (📖 51)	Normal
Smile timer (📖 51)	On
Blink proof (📖 51)	Off

Movie Menu

Option	Default value
Movie options (📖 82)	 TV movie 640★

Shooting Menu

Option	Default value
Image mode (📖 99)	 Normal (4000)
White balance (📖 101)	Auto
Continuous (📖 103)	Single
ISO sensitivity (📖 104)	Auto
Color options (📖 105)	Standard color
AF area mode (📖 106)	Face priority

Setup Menu

Option	Default value
Menus (📖 119)	Text
Welcome screen (📖 120)	None
Photo info (📖 124)	Auto info
Image review (📖 124)	On
Brightness (📖 124)	3
Date imprint (📖 125)	Off
Vibration reduction (📖 126)	On
Motion detection (📖 127)	Auto
AF assist (📖 128)	Auto
Digital zoom (📖 128)	On
Button sound (📖 129)	On
Shutter sound (📖 129)	On
Auto off (📖 129)	1 min
Blink warning (📖 132)	Off

Projector Menu

Option	Default value
Effects (📖 143)	Classic
Background music (📖 143)	None
Frame intvl (📖 143)	3 s

Projector Settings Menu

Option	Default value
Power saving (📖 145)	Off
Auto off (📖 145)	5 min
Tone compensation (📖 146)	On

Others

Option	Default value
Paper size (📖 91, 92)	Default
Slide show (📖 113)	3 s

- Choosing **Reset all** also clears the current file number (📖 148) from memory. Numbering will continue from the lowest number available. To reset file numbering to "0001", delete all pictures (📖 114) before selecting **Reset all**.
- The following menu settings will remain unaffected when menus are reset with **Reset all**.
Shooting menu: Preset manual data (📖 102) acquired for **White balance**
Setup menu: **Date** (📖 121), **Language** (📖 131), and **Video mode** (📖 131)

Ver. Firmware Version

MENU button → **Y** (Setup menu) (📖 118) → **Ver.** Firmware version

View the current camera firmware version.

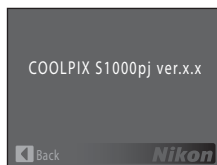

Displaying Pictures with the Projector (Projector Mode)

The COOLPIX S1000pj is equipped with a built-in projector. The ability to project pictures and movies with simple operation makes for a convenient way of enjoying photos at gatherings of family and friends.

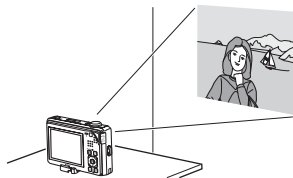

Projecting Pictures

1 Place the camera.

Place the projector stand (supplied) on a stable and level surface such as a table.

Place the camera on the projector stand so that the projection on the stand fits into the camera's tripod socket.

Position the camera so that the projector window is pointed at a flat white surface or movie or projector screen.

The projection distance between the camera and screen should be approximately 26 cm to 2 m (10 in. to 6 ft. 6 in.) (📖 139).

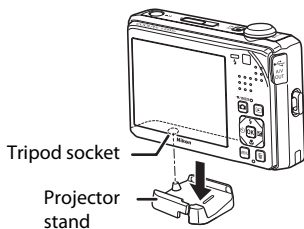

2 Turn on the camera and press the button.

The camera enters projector mode and a picture stored in the internal memory or on a memory card inserted into the camera is projected in full-frame playback mode onto the screen.

The camera's monitor turns off while projecting.

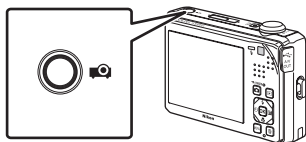

3 Adjust the camera position.

To change the projected picture size, adjust the distance between the camera and screen.

Adjust the projection angle to reduce picture distortion.

Projector Distortion

When the supplied projector stand is used, pictures are projected at a slightly upward angle to prevent the surface on which the stand and camera are placed from obstructing picture projection. The slightly upward angle of projection causes a type of distortion known as a keystone effect, skewing picture dimensions. Using a tripod rather than the supplied projector stand to stabilize the camera simplifies camera positioning and may also reduce the keystone effect.

4 Adjust focus for the projected picture.

Turn off unnecessary lights.

Slide the projector focus slider left or right to adjust picture focus.

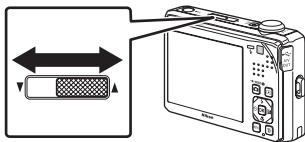

5 Switch the picture with the remote control (supplied).

Point the remote control at the infrared receiver on the front or rear of the camera (book 4, 5) within a distance of approximately 5 m (16 ft.).

Infrared emitter

Infrared receiver

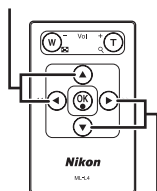
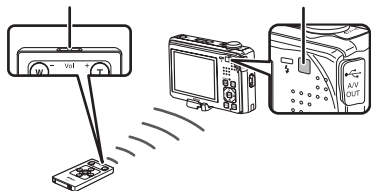

Display the previous picture



Display the next picture

The multi selector on the camera can also be used to operate the projector (book 140).









6 Press the button to end projection.

Projection also ends if the  button is pressed to switch to shooting mode, or the  button is pressed to switch to playback mode.

Notes on Using the Projector

- Be sure to read and follow the projector warnings on page iv.
- Be aware that the camera and battery will become hot in projector mode. Allow the camera to cool before using it again when the projector has been used for an extended period of time.
- When the battery is low, the camera automatically adjusts projection brightness to save power.
- Projection is not enabled while the playback-mode selection menu (book 10) is displayed, even when the  button is pressed.

Projecting Pictures Taken on a Specific Date or Sorted to a Category or Album

- 1 Press the  button on the camera to switch to playback mode.
- 2 Press the  button on the camera to display playback-mode selection menu.
 -  list by date mode: Pictures taken on the selected date can be projected.
 -  auto sort mode: Pictures sorted to the selected category with shooting can be projected.
 -  favorite pictures mode: Pictures added to the selected album can be projected.
- 3 Use the multi selector  or  on the camera to select playback mode, and press the  button.





A list screen of the selected date, category, or album is displayed.
- 4 Use the multi selector on the camera to select a date, category, or an album.
- 5 Press the  button.

Pictures taken on the selected date, sorted to the selected category or added to the selected album are projected.

Repeat steps 1 to 4 to change the selection of the date, category, or album.

Auto Power Off with Projection

When about five minutes (default setting) passes with no operation performed during projection, the camera ends projection to save power and enters standby mode. Once the camera has entered standby mode, the power-on lamp will blink, and if no operations are performed for another three minutes, the camera turns off automatically.







- When the power-on lamp is blinking in standby mode, press the power switch, shutter-release button or  button to activate playback mode. Press the  button to activate shooting mode.
- To resume projection, press the  button again in playback mode or shooting mode.
- The time allowed to pass before the camera enters standby mode when no operations are performed during projection can be changed from **Auto off** ( 145) in the projector settings menu ( 144).

Projection Distance and Projected Picture Size

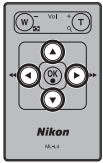
Projection distance	Projecting picture size
26 cm (10 in.)	Approx. 10 × 7.5 cm (4 × 3 in.; equivalent to 5-inch display)
50 cm (1 ft. 7 in.)	Approx. 20 × 15 cm (8 × 6 in.; equivalent to 10-inch display)
1.0 m (3 ft. 3 in.)	Approx. 40 × 30 cm (16 × 12 in.; equivalent to 20-inch display)
1.5 m (4 ft. 11 in.)	Approx. 60 × 45 cm (24 × 18 in.; equivalent to 30-inch display)
2.0 m (6 ft. 6 in.)	Approx. 80 × 60 cm (32 × 24 in.; equivalent to 40-inch display)





Using Projector Mode

















While a picture is displayed full-frame in projector mode, the following operations can be performed with the camera or the remote control (📖 6).

To	Use	Description	📖
Select the picture		Press the multi selector ▲, ▼, ◀, or ▶ on the camera or remote control. Press and hold ▲, ▼, ◀, or ▶ to fast forward or rewind.	11
			
Playback zoom	T (🔍)	Zoom in to a maximum of 10x. Press the 🔍/OK button to return to full-frame playback mode. In projector mode, pictures enlarged with playback zoom cannot be cropped.	57, 80
View thumbnails	W (🖼️)	Display 9 pictures thumbnails. Press the multi selector ▲, ▼, ◀, or ▶ on the camera or remote control to select a picture. Press the 🔍/OK button to return to full-frame playback mode.	–
Playback movies		Movies are displayed with the 🎬 indicator. Press the 🔍/OK button to start playback.	141
			
Display the projector menu	MENU (camera only)	Display the projector menu in the camera's monitor.	142
Switch to playback mode	 (camera only)	Press the ▶ button.	10
Switch to shooting mode	 (camera only)	Press the 📷 button.	10

In projector mode, the remote control can be used only with projection.

Projecting Movies

In projector mode, movies are indicated by  in full-frame playback mode. Press the  button on the remote control or  button on the camera to play back movies ( 83). The following operations can be performed using the remote control ( 6) or camera with movie playback.

To	Use	Description
Rewind/fast forward		Hold down the ◀ or ▶ button to rewind/fast forward.
		
Pause		Pause playback. Playback controls are displayed at the bottom of the projected display. Press the ◀ or ▶ button on the camera (multi selector) or remote control to select the following controls.
		
		Rewind movie by one frame. Frame-by-frame rewind continues while the  /  button is held down.
		Advance movie by one frame. Frame-by-frame advance continues while the  /  button is held down.
		Press the  /  button to resume playback.
	Press the  /  button to return to full-frame playback mode.	
Adjust volume	T (+)/W (-)	Adjust the volume of movie sound.

Projector Slide Show

Project pictures stored in the internal memory or on the memory card as an automated slide show.

1 Press the **MENU** button on the camera in projector mode.

The projector menu is displayed on the camera's monitor. Projection stops while the projector menu is displayed. The remote control cannot be used to apply projector mode settings.

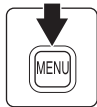

2 Use the multi selector on the camera to select **Start slide show** and press the **OK** button.

The monitor turns off and the standby screen is projected.

Select **Effects**, **Background music**, or **Frame intvl** and press the **OK** button to change slide show settings (143).

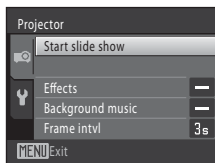

3 Check the camera position and focus with the standby screen.

Follow steps 3 and 4 under "Projecting Pictures" (137) to adjust camera position and focus.

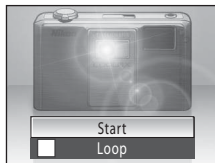

4 Press the **▲** or **▼** button on the remote control to select **Start** and press the **OK** button.

To repeat the slide show automatically, select **Loop** before selecting **Start** and press the **OK** button. A check mark (✓) will be added to the loop option when enabled.

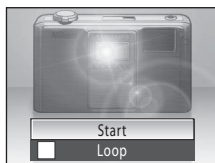

5 The slide show begins.

While the slide show is in progress, the following operations can be performed with the remote control.

Press **▶** to display the subsequent picture or **◀** to display the previous picture. Hold down either button to fast forward or rewind the slide show.

Press the **⏸** button to pause the slide show.

During a slide show with **Background music**, the volume can be adjusted with the **T** (+) or **W** (-) button.



6 End or resume the slide show.

When the slide show ends or is paused, playback controls are displayed at the bottom on the projection screen. Press the ◀ or ▶ button on the remote control to choose □ and press the ⏪ button to return to the projector menu, or choose ▶ to resume the slide show.



Slide Show Options

Select **Effects**, **Background music**, or **Frame intvl** in step 2 under “Projector Slide Show” (📖 142) to specify the following slide show options.

Effects

Select from **Classic** (default setting), **Reveal**, **Animated**, **Mosaic**, and **Page flip**.

Background music

Select from **Up-tempo**, **Moderate tempo**, **Slow tempo**, and **None** (default setting).

Frame intvl

Specify the length of time a picture is displayed.
Default setting is **3 s**.

Select **Manual advance only** to set so the displayed picture will not switch automatically, but can be switched by pressing the ◀ or ▶ button. Select this for a slide show with transition effects or background music.

✔ Notes on Slide Show

- Only the first frame of movies (📖 83) included in slide shows is displayed.
- The maximum playback time is up to 30 minutes even if **Loop** is enabled (📖 145).

📷 Slide Show Operation Using the Camera

The multi selector or zoom control **T** or **W** on the camera can also be used for operations described in steps 4 to 6 under “Projector Slide Show” (📖 142).

The Projector Settings Menu

Power saving (📖 145), **Auto off** (📖 145), and **Tone compensation** (📖 146) settings can be adjusted from the projector settings menu.

Displaying the Projector Settings Menu

- 1 Press the **MENU** button on the camera in projector mode to display the projector settings menu.

The projector menu is displayed on the camera's monitor.

While the menu is displayed, projection is stopped.

The menu screen cannot be operated with the remote control.

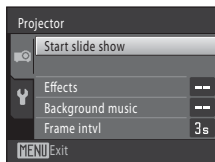
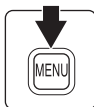

- 2 Press the multi selector ◀.

Tab selection is activated.

See "The Multi Selector" (📖 11) for more information.

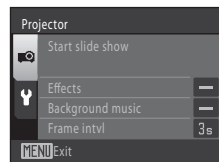

- 3 Press ▲ or ▼ to select the Y tab.

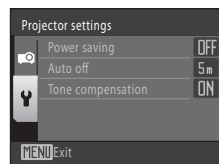

- 4 Press ▶ or the OK button.

Options in the projector settings menu can be selected.

To exit the projector settings menu, press the **MENU** button or ◀ to select a different tab.

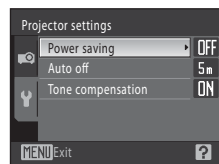

Power Saving

 button (projector mode) → MENU (Projector menu) →  (Projector settings menu) → Power saving

This option offers automatic adjustment of projection brightness to save power.

On

Enable power saving mode. Projection may appear slightly darker than when **Off** is selected.

Off (default setting)



Power saving mode is disabled. When the battery is low, the camera automatically adjusts projection brightness to save power even when **Off** is selected.

Auto Off

 button (projector mode) → MENU (Projector menu) →  (Projector settings menu) → Auto off

When the specified period of time passes with no operations performed in projector mode, the camera ends projection and enters standby mode ( 17) to save power. Once the camera has entered standby mode, the power-on lamp will blink, and if no operations are performed for another three minutes, the camera will turn off. Choose the time allowed to elapse before standby mode is initiated when no operations are performed in projector mode from **30 s, 1 min, 5 min** (default setting), and **30 min**.

Canceling Standby Mode

- When the camera enters standby mode from projector mode, press the power switch, shutter-release button or  button to activate playback mode.
- Press the  button to activate shooting mode.
- To resume projection, press the  button again in playback mode or shooting mode.

Notes on Auto Off

The time allowed to pass before the camera enters standby mode is fixed as follows:

- During slide show playback with the loop option enabled: 30 minutes
- When the projector menu or projector settings menu is displayed: three minutes

Tone Compensation

 button (projector mode) → MENU (Projector menu) →  (Projector settings menu) →
Tone compensation

Choose whether or not tones in projected pictures are compensated. The effect of tone compensation differs depending on pictures.

On (default setting)

Dark portions of projected pictures are brightened. Tone compensation is disabled with movie projection.

Off

Tone compensation is disabled.

Optional Accessories

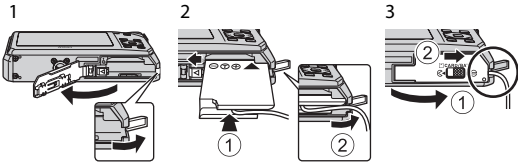
Rechargeable battery	Rechargeable Li-ion Battery EN-EL12
Battery charger	Battery Charger MH-65
AC adapter	<p>AC Adapter EH-62F</p> <p><Connecting the EH-62F></p>  <p>Insert the AC adapter cord into the groove deeply in the battery chamber before closing the battery-chamber/memory card slot cover. If the cord is not properly aligned in the groove, the cover and cord may be damaged when the cover is closed.</p>
USB cable	USB Cable UC-E6
A/V cable	Audio/Video Cable EG-CP14
Projector stand	Projector Stand ET-2
Remote control	Remote Control ML-L4

Approved Memory Cards

The following Secure Digital (SD) memory cards have been tested and approved for use in this camera.

All cards of the designated make and capacity can be used, regardless of speed.

SanDisk	512 MB, 1 GB, 2 GB ¹ , 4 GB ² , 8 GB ² , 16 GB ²
TOSHIBA	512 MB, 1 GB, 2 GB ¹ , 4 GB ² , 8 GB ² , 16 GB ²
Panasonic	512 MB, 1 GB, 2 GB ¹ , 4 GB ² , 8 GB ² , 16 GB ²
Lexar	1 GB, 2 GB ¹ , 4 GB ² , 8 GB ²

¹ If the memory card will be used with a card reader or similar device, be sure that the device supports 2 GB cards.

²  SDHC compliant.

If the memory card will be used with a card reader or similar device, be sure that the device is SDHC compliant.

Operation is not guaranteed with other makes of card. Contact the manufacturer for more information on the cards indicated above.

Image/Sound File and Folder Names

Pictures, movies or voice memos are assigned file names as follows.

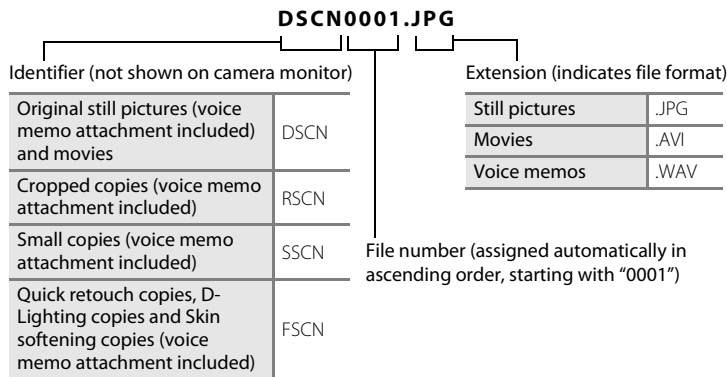

- Files are stored in folders named with a folder number followed by a five-character identifier: "P_" plus a three-digit sequential number for pictures taken in **Panorama assist** scene mode (e.g. "101P_001"; 📖 47) and "NIKON" for all other pictures (e.g. "100NIKON"). When the number of files within a folder reaches 9999, a new folder will be created. File numbers will be assigned automatically starting with "0001."
- Voice memo file names have the same identifier and file number as the picture to which the voice memo is attached.
- Files copied using **Copy>Selected images** are copied to the current folder, where they are assigned new file numbers in ascending order starting from the largest file number in memory. **Copy>All images** copies all folders from the source medium; file names do not change but new folder numbers are assigned in ascending order, starting from the largest folder number on the destination medium (📖 115).
- A single folder can hold up to 200 pictures; if the current folder already contains 200 pictures, a new folder, named by adding one to the current folder name, will be created the next time a picture is taken. If the current folder is numbered 999 and contains 200 pictures, or a picture is numbered 9999, no further pictures can be taken until the internal memory or memory card is formatted (📖 130), or a new memory card is inserted.

Caring for the Camera

To ensure continued enjoyment of this Nikon product, observe the following precautions when using or storing the device.

Keep dry

The device will be damaged if immersed in water or subjected to high humidity.

Do not drop

The product may malfunction if subjected to strong shock or vibration.

Handle the lens, projector window and all moving parts with care

Do not apply force to the lens, lens cover, projector window, monitor, memory card slot or battery chamber. These parts are easily damaged. Applying force to the lens cover could result in camera malfunction or damage to the lens. Should the monitor break, care should be taken to avoid injury caused by broken glass and to prevent the liquid crystal from the display touching the skin or entering the eyes or mouth.

Do not point the lens at strong light sources for extended periods

Avoid pointing the lens at the sun or other strong light sources for extended periods when using or storing the camera. Intense light may cause deterioration of the CCD image sensor, producing a white blur effect in photographs.

Keep away from strong magnetic fields

Do not use or store this device in the vicinity of equipment that generates strong electromagnetic radiation or magnetic fields. Strong static charge or the magnetic fields produced by equipment such as radio transmitters could interfere with the monitor, damage data stored on the memory card, or affect the product's internal circuitry.

Avoid sudden changes in temperature

Sudden changes in temperature, such as when entering or leaving a heated building on a cold day, can cause condensation to form inside the device. To prevent condensation, place the device in a carrying case or a plastic bag before exposing it to sudden changes in temperature.

Turn the product off before removing or disconnecting the power source

Do not remove the battery while the product is on, or while images are being recorded or deleted. Forcibly cutting power in these circumstances could result in loss of data or in damage to product memory or internal circuitry.

The Battery

- Check the battery level before using the camera and replace or charge the battery if necessary. Do not continue charging once the battery is fully charged as this will result in reduced battery performance. Whenever possible, carry a fully charged spare battery when taking pictures on important occasions.
- Do not use the battery at ambient temperatures below 0 °C (32 °F) or above 40 °C (104 °F). Failure to observe this precaution could damage the battery or impair its performance.
- Charge the battery indoors with an ambient temperature of 5 °C to 35 °C (41 °F to 95 °F) before use. When the battery temperature is between 0 and 10 °C (32 to 50 °F) or 45 to 60 °C (113 to 140 °F), the chargeable capacity may decrease. The battery will not charge if its temperature is below 0 °C (32 °F) or above 60 °C (140 °F).
- Note that the battery may become hot during use; wait for the battery to cool before charging. Failure to observe these precautions could damage the battery, impair its performance or prevent it from charging normally.
- On cold days, the capacity of batteries tends to decrease. Be sure that the battery is fully charged before heading outside to take pictures in cold weather. Keep spare batteries in a warm place and exchange as necessary. Once warmed, a cold battery may recover some of its charge.
- Dirt on the battery terminals can prevent the camera from functioning. Should the battery terminals become dirty, wipe them off with a clean, dry cloth before use.
- If the battery will not be used for some time, insert it in the camera and completely exhaust it before removing it for storage. The battery should be stored in a cool location with an ambient temperature of 15 to 25 °C (59 to 77 °F). Do not store the battery in hot or extremely cold locations.
- Always remove the battery from the camera or battery charger when it is not being used. When inserted, minute amounts of current flow even when unused, and the battery may become excessively drained and no longer function. Turning the camera on or off while the battery is exhausted can result in reduced battery life.
- Recharge the battery at least once every six months and completely exhaust it before returning it to storage.
- After removing the battery from the camera or battery charger, replace the supplied terminal cover and store in a cool place.
- A marked drop in the time a fully charged battery retains its charge, when used at room temperature, indicates that the battery needs to be replaced. Purchase a new EN-EL12 battery.
- Replace the battery when it no longer holds a charge. Used batteries are a valuable resource. Recycle used batteries in accordance with local regulations.

Cleaning

Lens/ projector window	Avoid touching the lens/projector window with your fingers. Remove dust or lint with a blower (typically a small device with a rubber bulb attached to one end that is pumped to produce a stream of air out the other end). To remove fingerprints or other stains that cannot be removed with a blower, wipe the lens/projector window with a soft cloth, using a spiral motion that starts at the center of them and working toward the edges. If this fails, clean them using a cloth lightly dampened with commercial lens cleaner.
Monitor	Remove dust or lint with a blower. To remove fingerprints and other stains, clean the monitor with a soft, dry cloth, being careful not to apply pressure.
Body	Use a blower to remove dust, dirt or sand, then wipe gently with a soft, dry cloth. After using the camera at the beach or other sandy or dusty environment, wipe off any sand, dust or salt with a dry cloth lightly dampened with fresh water and dry thoroughly. Note that foreign matter inside the camera could cause damage not covered by the warranty.

Do not use alcohol, thinner, or other volatile chemicals.

Storage

Turn the camera off when not in use. Be sure that the power-on lamp is off before putting the camera away. Remove the battery if the camera will not be used for an extended period. Do not store the camera with naphtha or camphor moth balls, or in any of the following locations:













- Next to equipment that produces strong electromagnetic fields, such as televisions or radios
- Exposed to temperatures below -10°C (14°F) or above 50°C (122°F)
- Places that are poorly ventilated or subject to humidity of over 60%
- To prevent mold or mildew, take the camera out of storage at least once a month. Turn the camera on and release the shutter a few times before putting the camera away again.

Notes on the Monitor

- The monitor may contain a few pixels that are always lit or that do not light. This is a characteristic common to all TFT LCD displays, and does not indicate a malfunction. Images recorded using the product will not be affected.
- White or colored streaks of light may be visible in the monitor with framing of bright subjects. This phenomenon, known as “smear,” occurs when extremely bright light strikes the image sensor. This is due to characteristics of the image sensor and does not indicate a malfunction. Smear may also cause partial discoloration in monitor display with shooting. Smear does not affect recorded images except when shooting with **Continuous** set to **Multi-shot 16** and when recording movies. When shooting in these modes, avoiding bright objects such as the sun, reflections of the sun, and electric lights is recommended.
- Images in the monitor may be difficult to see under bright lighting.
- The monitor is lit by an LED backlight. Should the monitor begin to dim or flicker, contact your Nikon-authorized service representative.

Error Messages



















The following table lists the error messages and other warnings displayed in the monitor, as well as the solutions for dealing with them.

Display	Problem	Solution	
 (blinks)	Clock not set.	Set date and time.	121
	Battery running low.	Prepare to charge or replace battery.	14, 16
 Battery exhausted.	Battery exhausted.	Charge or replace battery.	14, 16
 Battery temperature high	Battery temperature is high.	Turn off camera, and allow battery to cool down before resuming use. After 5 seconds, this message will disappear, the monitor will turn off, and the power-on lamp and flash lamp will blink rapidly. After the lamps blink for three minutes, the camera will turn off automatically. Pressing the power switch also turns off the camera.	17
 ● (● blinks red)	Camera cannot focus.	<ul style="list-style-type: none"> • Refocus. • Use focus lock. 	26, 27 107
 Please wait for the camera to finish recording.	Camera cannot perform other operations until recording is complete.	Wait until message clears from display automatically when recording is complete.	–
 Memory card is write protected.	Write-protect switch is in “lock” position.	Slide write-protect switch to “write” position.	21
 This card cannot be used.	Error accessing memory card.	<ul style="list-style-type: none"> • Use approved card. • Check that connectors are clean. • Confirm that memory card is correctly inserted. 	147
 This card cannot be read.			20
 Card is not formatted. Format card? No Yes	Memory card has not been formatted for use in this camera.	Formatting deletes all data stored on the memory card. Be sure to select No and make copies of any pictures you wish to keep before formatting the memory card. Select Yes and press the  button to format the memory card.	21

Display	Problem	Solution	
i Out of memory.	Memory card is full.	<ul style="list-style-type: none"> Choose smaller image size. Delete pictures. Insert new memory card. Remove memory card and use internal memory. 	99 28, 83, 114 20 20
i Image cannot be saved.	Error occurred while recording picture.	Format internal memory or memory card.	130
	Camera has run out of file numbers.	Insert a new memory card or format internal memory card/memory card.	148
	Picture cannot be used for welcome screen.	The following pictures cannot be stored. <ul style="list-style-type: none"> Pictures taken at an Image mode setting of 16:9 (3968) Pictures reduced to 320 × 240 size or smaller with cropping or small picture editing 	120
	Insufficient space to save a copy.	Delete pictures from destination.	114
i Album is full. No further pictures can be added.	Over 200 pictures have already been added to album.	Remove some pictures from album.	68
		Add to other albums.	66
i Sound file cannot be saved.	As a picture is currently recorded, a voice memo cannot be attached to the picture.	Attach a voice memo after recording the picture.	27
	As the battery is low, a voice memo cannot be attached.	Charge or replace battery.	14, 16
	A voice memo cannot be attached to this file.	<ul style="list-style-type: none"> Select a picture taken with this camera. Voice memos cannot be attached to movies. 	72 –
i A blink was detected in the picture just taken.	One or more portrait subjects may have blinked when the picture was taken.	Check the picture in playback mode.	51
i Image cannot be modified.	Cannot edit selected picture.	<ul style="list-style-type: none"> Be sure that the picture meets editing requirements. Movies cannot be edited. 	73 –

Error Messages

Display	Problem	Solution	
i Cannot record movie.	Time out error while recording movie.	Choose memory card with faster write speed.	20
i Memory contains no images.	No pictures in the internal memory or memory card.	<ul style="list-style-type: none"> To play back pictures stored in internal memory, remove memory card from the camera. To copy picture from internal memory to memory card, press the MENU button. The copy screen will be displayed and pictures in the internal memory can be copied to memory card. 	20 115
	No pictures are contained in the folder selected in auto sort mode.	Select the folder containing the sorted pictures.	62
	The picture has not been added to album.	<ul style="list-style-type: none"> Add the picture to album. Choose the album that the picture was added. 	66 67
i The camera will turn off to prevent overheating.	The camera has become hot due to the heat of the projector. The camera turns off automatically.	Leave the camera off until it has cooled and then turn it on again.	138
i File contains no image data.	File not created with this camera.	File cannot be viewed on this camera. View file using a computer or the devices used to create or edit this file.	-
i This file cannot be played back.			
i All images are hidden.	No pictures available for a slide show.	-	113
i This image cannot be deleted.	Picture is protected.	Disable protection.	114
i Travel destination is in the current time zone.	Destination in same time zone as home.	-	121



Display	Problem	Solution	
Lens error 	Lens error.	Turn camera off and then on again. If error persists, contact retailer or Nikon-authorized service representative.	22
 Communications error	USB cable disconnected during data transfer to printer.	Turn camera off and reconnect cable.	90
System error 	Error has occurred in camera's internal circuitry.	Turn camera off, remove and reinsert battery, and turn camera on. If error persists, contact retailer or Nikon-authorized service representative.	17
 Printer error: check printer status.	Printer error.	Check printer. After solving the problem, select Resume and press the  button to resume printing.*	–
 Printer error: check paper	Specified size of paper is not loaded in printer.	Load the specified paper, select Resume and press the  button to resume printing.*	–
 Printer error: paper jam	Paper has jammed in the printer.	Remove the jammed paper, select Resume and press the  button to resume printing.*	–
 Printer error: out of paper	No paper is loaded in printer.	Load the specified paper, select Resume and press the  button to resume printing.*	–
 Printer error: check ink	Ink error.	Check ink, select Resume and press the  button to resume printing.*	–
 Printer error: out of ink	Running out of ink or ink cartridge is empty.	Replace ink cartridge, select Resume and press the  button to resume printing.*	–
 Printer error: file corrupt	An error caused by the image file has occurred.	Select Cancel and press the  button to cancel printing.	–

* See the documentation provided with your printer for further guidance and information.

Troubleshooting

If the camera fails to function as expected, check the list of common problems below before consulting your retailer or Nikon-authorized service representative.

Display, Settings and Power Supply



Problem	Cause/Solution	
Monitor is blank.	<ul style="list-style-type: none">• Camera is off.• Battery is exhausted.• Standby mode for saving power: press the power switch, the shutter-release button, the  button, or the  button.• When flash lamp blinks red, wait until flash has charged.• Camera and computer are connected via USB cable.• Camera and TV are connected via A/V cable.• Monitor turns off during projecting.	17 16 129 31 85 84 137
Monitor is hard to read.	<ul style="list-style-type: none">• Adjust monitor brightness.• Monitor is dirty. Clean monitor.	124 151
Camera turns off without warning.	<ul style="list-style-type: none">• Battery is exhausted.• Camera has turned off automatically to save power. • The camera has become hot due to the heat of the projector. Leave the camera off until it has cooled and then turn it on again.• Battery is cold.	22 129, 145 138, 154 150
Date and time of recording are not correct.	<ul style="list-style-type: none">• Pictures and movies recorded before the clock has been set will have a time stamp of "00/00/0000 00:00" for pictures and "01/01/2009 00:00" for movies. The "Date not set" indicator blinks during shooting. Set the correct time and date from the Date option in the setup menu.• Check camera clock regularly against more accurate timepieces and reset as required.	18, 121 121
No indicators displayed in monitor.	Hide info is selected for Photo info . Select Show info .	124
Date imprint not available.	Camera clock has not been set.	18, 121
Date not appearing on pictures even when Date imprint is enabled.	<ul style="list-style-type: none">• The current shooting mode is one that does not support Date imprint.• Another function that does not support date imprint is enabled.	125 110, 125
Camera settings reset.	Backup battery is exhausted; all settings were restored to their default values.	122

Problem	Cause/Solution	
Monitor turns off, and the power-on lamp blinks rapidly.	Battery temperature is high. Turn off camera and allow battery to cool down before resuming use. After the lamps blink for three minutes, the camera will turn off automatically. Pressing the power switch also turns off the camera.	17
Camera does not respond to remote control operation.	<ul style="list-style-type: none"> • Battery of the remote control is exhausted. • Point the remote control at the infrared receiver on the front or rear on the camera at the distance within approximately 5 m (16 ft.). • When Smile timer is set to On in smart portrait mode, and the camera recognizes human faces, remote control operation is not available. • The shutter may not be released when attempting to use the remote control to take pictures of scenes exhibiting severe backlighting. 	7 35, 138 50 –



Electronically Controlled Cameras









In extremely rare instances, unusual characters may appear in the monitor and the camera may stop functioning. In most cases, this phenomenon is caused by a strong external static charge. Turn the camera off, remove and replace the battery, then turn the camera on again. In the event of continued malfunction, contact your retailer or Nikon-authorized service representative. Note that disconnecting the power source as described above may result in the loss of any data not recorded to internal memory or the memory card at the time the problem occurred. Data already recorded will not be affected.

Shooting

Problem	Cause/Solution	
No picture taken when shutter-release button is pressed.	<ul style="list-style-type: none"> • When camera is in playback mode, press the  button or the shutter-release button. • When menus are displayed, press the MENU button. • Battery is exhausted. • When flash lamp blinks, flash is charging. 	10, 28 12 22 31

Troubleshooting

Problem	Cause/Solution	
Camera cannot focus.	<ul style="list-style-type: none"> • The intended subject is one with which autofocus does not perform well. • Select Auto for AF assist in set up menu. • Focus error. Turn camera off and then on again. 	27 128 22
Pictures are blurred.	<ul style="list-style-type: none"> • Use flash. • Increase the ISO sensitivity value. • Enable vibration reduction or motion detection. • Use BSS. • Use tripod and self-timer. 	30 104 126, 127 103 32
Bright specks appear in pictures taken with flash.	Flash is reflecting off particles in air. Turn flash off.	31
Streaks of light or partial discoloration are visible in the monitor.	Smear occurs when extremely bright light strikes the image sensor. When shooting with Continuous set to Multi-shot 16 and when recording movies, avoiding bright objects, such as the sun, reflections of the sun, and electric lights is recommended.	151
Flash does not fire.	<ul style="list-style-type: none"> • Flash is off. • Some scene modes with which the flash does not function is selected. • On is selected for Blink proof in smart portrait menu. •  mode is selected. • Another function that restricts flash is enabled. 	30 37-42 51 81 110
Optical zoom cannot be used.	Optical zoom cannot be used while recording movies.	81
Digital zoom cannot be used.	<p>Digital zoom is set to Off in the setup menu. Digital zoom is not available in the following situations.</p> <ul style="list-style-type: none"> • When Scene auto selector, Portrait, or Night portrait is selected for scene mode. • When shooting in smart portrait mode. • When shooting in subject tracking mode. • Just before recording a movie (up to 2x can be applied while recording movies). • When Continuous is set to Multi-shot 16. 	128 37, 38 49 52 81 103
Image mode not available.	Another function that restricts the Image mode option is enabled.	110

Problem	Cause/Solution	
Skin tones are not softened.	<ul style="list-style-type: none"> • Under some shooting conditions, facial skin tones may not be softened. • Use Skin softening in the playback menu for pictures containing more than three faces. 	50 77
No sound when shutter is released.	<ul style="list-style-type: none"> • Off is selected for Sound settings>Shutter sound in setup menu. • Continuous, Multi-shot 16 or BSS is selected for the Continuous setting in shooting menu. •  (Sports scene mode) or  (Museum scene mode) is selected. •  mode is selected. • The speaker is blocked. Do not cover the speaker. 	129 103 38, 41 81 5, 24
AF-assist illuminator does not light.	<ul style="list-style-type: none"> • Off is selected for AF assist in the setup menu. • AF-assist illuminator turns off automatically in some scene modes. 	128 37-42
Pictures appear smeared.	Lens is dirty. Clean lens.	151
Colors are unnatural.	White balance does not match light source.	101
Randomly spaced bright pixels ("noise") appear in image.	Shutter speed is too slow or ISO sensitivity is high as the subject is dark. Noise can be reduced by: <ul style="list-style-type: none"> • Using flash. • Specifying a lower ISO sensitivity setting. • Using a scene mode which has noise reduction ability. 	30 104 37-42
Pictures are too dark (underexposed).	<ul style="list-style-type: none"> • Flash is off. • Flash window is blocked. • Subject is beyond flash range. • Adjust exposure compensation. • Increase ISO sensitivity. • Subject is backlit. Select  (Backlight) scene mode or use fill flash. 	30 24 30 34 104 30, 42
Pictures are too bright (overexposed).	Adjust exposure compensation.	34
Unexpected results when flash set to  (auto with red-eye reduction).	When taking pictures with  (auto with red-eye reduction) or fill flash with slow sync and red-eye reduction in Night portrait scene mode, In-Camera Red Eye Fix may be applied to areas not affected by red-eye. Use any scene mode other than Night portrait , and change the flash to any setting other than  (auto with red-eye reduction) and try shooting again.	30, 38

Playback

Problem	Cause/Solution	
File cannot be played back.	File or folder was overwritten or renamed by computer or other make of camera.	–
Cannot zoom in on picture.	Playback zoom cannot be used with movies, small pictures, or pictures that have been cropped to a size of 320 × 240 or smaller.	–
Cannot record or play back voice memos.	<ul style="list-style-type: none"> • Voice memos cannot be attached to movies. • Voice memos cannot be attached to images taken with other cameras. Voice memos attached to images using another camera cannot be played back on this camera. 	83 72
Cannot use quick retouch, D-Lighting, skin softening, small picture, or crop.	<ul style="list-style-type: none"> • These options cannot be used with movies. • These options cannot be used with pictures taken at an Image mode setting of IS 16:9 (3968). • Select pictures that support quick retouch, D-Lighting, skin softening, small picture, or crop. • Camera is unable to edit pictures taken with other cameras. 	83 99 73 73
Pictures not displayed on television.	<ul style="list-style-type: none"> • Select correct Video mode. • Memory card contains no pictures. Replace the memory card. Remove the memory card to play back pictures from the internal memory. 	131 20
Album icon restored to default settings, or pictures added to album not displayed in favorite pictures playback.	Data in the memory card may not be played back correctly if overwritten by a computer.	–
The recorded pictures are not displayed in auto sort mode.	<ul style="list-style-type: none"> • The desired picture was sorted to a category other than the category currently displayed. • Pictures recorded by a camera other than the COOLPIX S1000pj and pictures copied using the copy option cannot be displayed in auto sort mode. • Pictures recorded to internal memory or memory card may not be played back correctly if overwritten by a computer. • Up to 999 pictures and movie files can be added to each category. If the desired category already contains 999 pictures, new pictures or movies cannot be added. 	61 62 – –

Problem	Cause/Solution	
Nikon Transfer does not start when camera is connected.	<ul style="list-style-type: none"> • Camera is off. • Battery is exhausted. • USB cable is not properly connected. • Camera is not recognized by the computer. • Computer is not set to start Nikon Transfer automatically. For more information on Nikon Transfer, refer to help information contained in Nikon Transfer. • Be sure that the computer meets Nikon Transfer system requirements. 	22 22 86 – – 85
Pictures to be printed are not displayed.	Memory card contains no pictures. Replace the memory card. Remove the memory card to print pictures from the internal memory.	20
Cannot select paper size with camera.	Paper size cannot be selected from the camera if the printer does not support the paper sizes used by the camera, or the printer automatically selects the paper size. Use the printer to select paper size.	91, 92
Projected pictures are not sharp.	<ul style="list-style-type: none"> • Projector window is dirty. • The camera is placed too far or too close to the screen. Adjust the distance between the camera and the screen. • The picture is out of focus. Adjust the focus with the projector focus slider. 	151 137 138

Specifications

Nikon COOLPIX S1000pj Digital Camera

Type	Compact digital camera
Effective pixels	12.1 million
Image sensor	¹ /2.3-in. CCD; total pixels: approx. 12.39 million
Lens	5x optical zoom, NIKKOR lens
Focal length	5.0–25.0mm (equivalent with 35mm [135] format picture angle: 28–140mm)
f/-number	f/3.9–5.8
Construction	13 elements in 9 groups
Digital zoom	Up to 4x (equivalent with 35mm [135] format picture angle: approx. 560mm)
Vibration reduction	Combination lens-shift and electronic VR
Autofocus (AF)	Contrast-detect AF
Focus range (from lens)	<ul style="list-style-type: none">• Approx. 30 cm (1 ft.) to ∞ (W); approx. 50 cm (1 ft. 8 in.) to ∞ (T)• Macro mode: Approx. 3 cm (1.2 in.) to ∞ (zoom indicator positioned to the left of  to maximum wide-angle position)
Focus-area selection	Auto (9-area automatic selection), center, manual with 99 focus areas, face priority
Monitor	2.7-in., approx. 230k-dot, TFT LCD and 5-level brightness adjustment
Frame coverage (shooting mode)	Approx. 97% horizontal and 97% vertical (Compared to actual picture)
Frame coverage (playback mode)	Approx. 100% horizontal and 100% vertical (Compared to actual picture)
Storage	
Media	<ul style="list-style-type: none">• Internal memory (approx. 36 MB)• SD (Secure Digital) memory cards
File system	DCF, Exif 2.2, and DPOF compliant
File formats	Still pictures: JPEG Movies: AVI (Motion-JPEG compliant) Sound files: WAV
Image size (pixels)	<ul style="list-style-type: none">• 4,000 × 3,000 High (4000★)/Normal (4000)• 3,264 × 2,448 Normal (3264)• 2,592 × 1,944 Normal (2592)• 2,048 × 1,536 Normal (2048)• 1,024 × 768 PC screen (1024)• 640 × 480 TV screen (640)• 3,968 × 2,232 16:9 (3968)
ISO sensitivity (Standard output sensitivity)	ISO 80, 100, 200, 400, 800, 1600, 3200, 6400, Auto (auto gain from ISO 80 to 800), Fixed range auto (ISO 80-200, ISO 80-400)

Exposure	
Metering	256-segment matrix, center-weighted (digital zoom less than 2x), spot (digital zoom 2x or more)
Exposure control	Programmed auto exposure with motion detection and exposure compensation (-2.0 to +2.0 EV in steps of $\frac{1}{3}$ EV)
Range (ISO 100)	[W]: -1.1 to +16.9 EV [T]: 2.2 to 18 EV
Shutter	
Speed	$\frac{1}{1500}$ -2 s 4 s (when scene mode is set to Fireworks show)
Aperture	
Range	Electronically-controlled ND filter (-2 AV) selection 2 steps (f/3.9 and f/7.8 [W])
Self-timer	Can be selected from 10 and 2 second duration
Built-in flash	
Range (approx.) (ISO sensitivity: Auto)	[W]: 0.3 to 3.5 m (1 to 11 ft.) [T]: 0.5 to 2.5 m (1 to 8 ft.)
Flash control	TTL auto flash with monitor preflashes
Interface	
Data Transfer Protocol	Hi-Speed USB MTP, PTP
Video output	Can be selected from NTSC and PAL
I/O terminal	Audio video output/digital I/O (USB)
Projector	
Projection system	Single lamp/single LCD panel
LCD panel	One 0.4-in. reflective panel with an aspect ratio of 4 : 3, approx. 921k-dot
Projector lens	21mm f/3.5, manual focus
Light source	One high luminance white LED
Image size	5 to 40 in.
Throw distance	Approx. 0.26 to 2 m (10 in. to 6 ft. 6 in.)
Number of colors	Full color (approx. 16.7 million colors)
Brightness ¹	Up to 10 lumens
Contrast ratio	30 : 1
Resolution (output)	VGA equivalent
Endurance (battery life)	Approx. 1 h with EN-EL12 battery

Specifications

Supported languages	Arabic, Chinese (Simplified and Traditional), Czech, Danish, Dutch, English, Finnish, French, Greek, German, Hungarian, Indonesian, Italian, Japanese, Korean, Polish, Portuguese, Norwegian, Russian, Spanish, Swedish, Thai, Turkish
Power sources	One EN-EL12 Rechargeable Li-ion Battery (supplied) AC Adapter EH-62F (available separately)
Battery life ²	Approx. 220 shots (EN-EL12)
Dimensions (W × H × D)	Approx. 99.5 × 62.5 × 23 mm (4 × 2.5 × 0.9 in.) (excluding projections)
Weight	Approx. 155 g (5.5 oz.) (without battery and SD memory card)
Operating environment	
Temperature	0 to 40 °C (32 to 104 °F) When using the projector: 0 to 35 °C (32 to 95 °F)
Humidity	Less than 85% (no condensation)

- Unless otherwise stated, all figures are for a camera with a fully-charged Rechargeable Li-ion Battery EN-EL12 operated at an ambient temperature of 25 °C (77 °F).

¹ Measurement, measuring conditions, and method of notation all comply with ISO 21118.

² Based on Camera and Imaging Products Association (CIPA) standards for measuring the life of camera batteries. Measured at 23 °C (73 °F); zoom adjusted with each shot, flash fired with every other shot, image mode set to **2.4 Normal (4000)**. Battery life may vary depending on shooting interval and length of time menus and images are displayed.

Rechargeable Li-ion Battery EN-EL12

Type	Rechargeable lithium-ion battery
Rated capacity	DC 3.7 V, 1050 mAh
Operating temperature	0 to 40 °C (32 to 104 °F)
Dimensions (W × H × D)	Approx. 32 × 43.8 × 7.9 mm (1.3 × 1.7 × 0.3 in.) (excluding projections)
Weight	Approx. 22.5 g (0.8 oz) (excluding terminal cover)

Battery Charger MH-65

Rated input	AC 100-240 V, 50/60 Hz, 0.08-0.05 A
Rated capacity	8-12 VA
Rated output	DC 4.2 V, 0.7 A
Battery	Rechargeable Li-ion Battery EN-EL12
Charging time	Approx. 2 hours 30 minutes when battery is fully discharged
Operating temperature	0 to 40 °C (32 to 104 °F)
Dimensions (W × H × D)	Approx. 58 × 27.5 × 80 mm (2.3 × 1.1 × 3.1 in.) (excluding power cable)
Length of power cable	Approx. 1.8 m (6 ft.)
Weight	Approx. 70 g (2.5 oz) (excluding power cable)

✓ Specifications





























Nikon will not be held liable for any errors this manual may contain. The appearance of this product and its specifications are subject to change without notice.

Supported Standards

- **DCF:** Design Rule for Camera File System is a standard widely used in the digital camera industry to ensure compatibility among different makes of camera.
- **DPOF:** Digital Print Order Format is an industry-wide standard that allows pictures to be printed from print orders stored on memory cards.
- **Exif version 2.2:** This camera supports Exchangeable image file format (Exif) version 2.2 for digital still cameras, a standard that allows information stored with photographs to be used for optimal color reproduction when images are output from Exif-compliant printers.
- **PictBridge:** A standard developed cooperatively by the digital camera and printer industries, allowing photographs to be output directly to a printer without connecting the camera to a computer.

Index

Symbols



-  Auto mode 22
-  Scene mode 36
-  Smart portrait mode 49
-  Subject tracking mode 52
-  Movie mode 81
-  Projector mode 137
-  Setup menu 117
-  Projector settings menu 144
-  List by date mode 58
-  Auto sort mode 61
-  Favorite pictures mode 64
- T** (Tele) 4, 25
- W** (Wide) 4, 25
-  Playback zoom 4, 57
-  Thumbnail playback 4, 54
-  Help 4, 13
-  Apply selection button 5, 11
-  Apply selection button 6, 35, 140
-  Delete button 5, 28, 29, 72, 83
-  Playback mode 5, 10, 28
-  Self timer 32
-  Flash mode 30
-  Macro mode 33
- MENU** Menu button 5
-  (Shooting mode) button 5, 10
-  (Projector) button 4, 13, 137
-  Exposure compensation 34
- AE/AF-L** 48
- A**
 - A/V cable 84
 - AC adapter 17
 - AF area 26
 - AF area mode 106
 - AF assist 128
 - Audio-in/Video-in jack 84
 - Auto flash 30
 - Auto mode 22
 - Auto off 129, 145
 - Auto sort menu 63
 - Auto sort mode 61
 - Autofocus 33, 53
 - AVI 148
- B**
 - Back light  42
 - Battery 14, 16, 122
 - Battery chamber 5
 - Battery charger 147
 - Battery latch 5
 - Battery level 22
 - Battery-chamber/memory card slot cover 5, 16, 20
 - Beach/snow  39
 - Best Shot Selector 103
 - Black-and-white 105
 - Blink proof 51
 - Blink warning 132
 - Brightness 124
 - BSS 103
 - Built-in flash 4, 30
 - Built-in microphone 4, 71
 - Button sound 129
- C**
 - Cable connector 4, 84, 85, 89
 - Calendar display 56
 - Close-up  40
 - Cloudy 101
 - Color options 105
 - Compression ratio 99
 - Computer 85, 85–88
 - copying pictures to 85–88
 - Connector cover 4
 - Continuous 103
 - Copy  42
 - Copying pictures 115
 - Crop 80
 - Cyanotype 105
- D**
 - Date 18, 121
 - Date imprint 125

Daylight 101
Daylight saving time 18, 122
Delete 114
Digital zoom 25, 128
Direct print 89
D-Lighting 76
DPOF print 94
DSCN 148
Dusk/dawn  39

E

EN-EL12 14, 16
Exposure compensation 34
Extension 148
Eyelet for camera strap 4

E

Face priority 106
Favorite pictures menu 69
Favorite pictures mode 69
File names 148
Fill flash 30
Fireworks show  41
Firmware version 136
Fixed range auto 104
Flash 30, 31
Flash lamp 5, 31
Flash off 30
Fluorescent 101
Focus 26, 106
Focus lock 107
Folder name 148
Food  45
Format 21, 130
Format memory card 21, 130
Formatting internal memory 130
FSCN 148
Full-frame playback 28, 29

H

Halfway 27
Help 13

I

Identifier 148
Image mode 23, 36, 51, 53, 99
Image review 124
Image size 99
Incandescent 101
Internal memory 20
ISO sensitivity 31, 104

J

JPG 148



L

Landscape  37
Language 131
Lens 4, 162
List by date menu 60
List by date mode 58
Lithium-ion type battery 14

M

Macro mode 33
Memory capacity 22
Memory card 20, 147
Memory card slot 5, 20
Menus 119
Monitor 5, 8, 151
Monitor settings 124
Motion detection 127
Movie menu 82
Movie playback 83
Movie recording 81
Movie settings 82
Multi selector 5, 11
Multi-shot 16 103
Museum  41



N

Night landscape  40
Night portrait  38
Noise reduction 38, 40
Number of exposures remaining 22, 100

O

Optional accessories 147

P

Panorama assist  42, 47
 Paper size 91, 92
 Party/indoor  39
 Photo info 124
 PictBridge 89, 166
 Playback 28, 29, 54, 57
 Playback menu 111
 Playback zoom 57
 Playback-mode selection menu 10
 Portrait  37
 Power 18, 22
 Power saving 145
 Power switch 4, 22
 Power-on lamp 4, 22
 Preset manual 102
 Print 91, 92, 95
 Print set 95
 Print Set (Date) 96
 Printer 89
 Projector focus slider 4, 138
 Projector menu 137
 Projector mode 137
 Projector settings menu 144
 Projector stand 7, 137
 Projector window 4, 137
 Protect 114

Q



Quick retouch 75

R

Rechargeable battery 147
 Rechargeable Li-ion battery 16
 Recording movies 81
 Red-eye reduction 30, 31
 Remote control 6, 35, 138
 Reset all 134
 Rotate image 115
 RSCN 148

S

Scene auto selector  37, 43

Scene mode 36, 37
 Self-timer 32
 Self-timer lamp 4, 32
 Sepia 105
 Setup menu 117
 Shooting 22, 24, 26
 Shooting menu 98
 Shooting-mode selection menu 10
 Shutter sound 129
 Shutter-release button 4, 26
 Single 103
 Skin softening 51, 77
 Slide show 113, 142
 Slow sync 30
 Small picture 79
 Smart portrait menu 51
 Smart portrait mode 49
 Smile timer 51
 Sound settings 129
 Speaker 5
 Sports  38
 SSCN 148
 Standard color 105
 Strap 7
 Subject tracking mode 52
 Sunset  39

T

Thumbnail playback 54
 Time zone 121, 123
 Tone compensation 146
 Tripod socket 5, 137
 TV 84
 TV movie 82

U

USB cable 85, 86, 90

V

Vibration reduction 126
 Video mode 131
 Vivid color 105
 Voice memo 71

Index

Volume 83

W

WAV 148

Welcome screen 120

White balance 101

Z

Zoom control 4, 25, 83, 140

Nikon

No reproduction in any form of this manual, in whole or in part (except for brief quotation in critical articles or reviews), may be made without written authorization from NIKON CORPORATION.



NIKON CORPORATION

Fuji Bldg., 2-3 Marunouchi 3-chome,
Chiyoda-ku, Tokyo 100-8331, Japan

© 2009 Nikon Corporation

YP9H01(11)
6MM71911-01